



BD's Revolutionary New Heavy-Duty Lift Pump System

1998-02 DODGE CUMMINS 24V ISB ***FLOWMAX LIFT PUMP KIT***

Installation Instructions

Part# 1050301B

PLEASE READ ALL INSTRUCTIONS CAREFULLY BEFORE INSTALLATION.











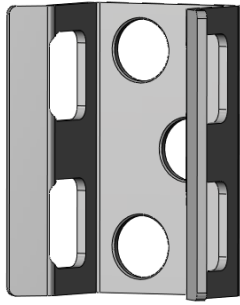
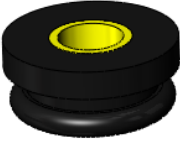

BD Engine Brake Inc.

Plant Address: 33541 MacLure Rd. Abbotsford, BC, Canada V2S 7W2

U.S. Shipping Address: 88-446 Harrison St, Sumas, WA 98295 U.S. Mailing Address: P.O. Box 231, Sumas, WA 98295

Phone: 604-853-6096 | Fax: 604-853-8749 | Internet: www.bd-power.com

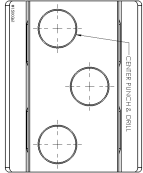
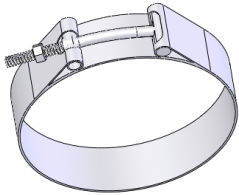
Kit Contents

1500350-L-REV-A		1500357	1500359	1500355
				
FLOWMAX Lift Pump		Flat Washer	Self Threading Bolt	Pump Bracket
Qty: 1		Qty: 3	Qty: 3	Qty: 1
1500356	1300529	1505001	1500311	
				
FlowMAX Anti-Vibration Mount	Self Tapping Screw	Hose Clamp	-AN 8 ORB x 3/8" Barb	
Qty: 3	Qty: 1	Qty: 7	Qty: 2	
1500310		1502033	1502021	
				
FlowMAX Lift Pump Wiring Harness		M12 x -8 JICM Adapter	3/8" Fuel Hose	
Qty: 1		Qty: 1	Qty: 78"	
1502034	1500361	1500358	1500340	
				
-8 JICF x 3/8" 90° ADAPTER	Drill Jig	T-Bolt Clamp	3/8 Fuel Strainer	
Qty: 1	Qty: 1	Qty: 2	Qty: 1	

BD Engine Brake Inc.

Plant Address: 33541 MacLure Rd. Abbotsford, BC, Canada V2S 7W2

U.S. Shipping Address: 88-446 Harrison St, Sumas, WA 98295 U.S. Mailing Address: P.O. Box 231, Sumas, WA 98295

Phone: 604-853-6096 | Fax: 604-853-8749 | Internet: www.bd-power.com

Before You Begin

The FlowMax pump is designed to be a stand-alone pump system and is not designed to be used in conjunction with stock lift pumps. If your truck has been retrofitted with the Chrysler in-tank lift pump you will have to lower the fuel tank & delete the pump from in the tank. BD offers a simple retrofit kit complete with instructions & the pieces needed to do this, part number 1050302. If you are unsure if your truck has been retrofitted simply check that the factory lift pump is still in place on the engine next to the fuel filter housing (see diagram on pages 9 & 10); if it is not there then your truck has the in-tank pump.

Optional Accessories

- **1081130** - Low Fuel Pressure LED Alarm kit
- **1085210** – X-Monitor Digital Gauge Package
- **1080156** – Fuel Pressure Kit (X-Monitor Accessory)

Required Tools:

- 5mm Allen wrench
- Drill
- 1/8" and 11/32" Drill bits
- Pliers
- 3/16" Flat Screwdriver
- 10 mm Socket or wrench
- Small Pipe Cutter
- Knife To Cut Fuel Hose
- 9/16" Socket or Wrench
- 7/16" Socket or Wrench

Installation

1. Disconnect both batteries.
2. Raise the vehicle and support it safely.
3. Unbolt the front driveshaft (4x4 only) for ease of installation.

Pump Installation

Locate a spot on the driver's side frame rail near the front of the vehicle so that there is room to use a drill. Tape the drill template in place. Ensure there is ample room and nothing will contact the pump at this location.

BD Engine Brake Inc.

Plant Address: 33541 MacLure Rd. Abbotsford, BC, Canada V2S 7W2

U.S. Shipping Address: 88-446 Harrison St, Sumas, WA 98295 U.S. Mailing Address: P.O. Box 231, Sumas, WA 98295

Phone: 604-853-6096 | Fax: 604-853-8749 | Internet: www.bd-power.com

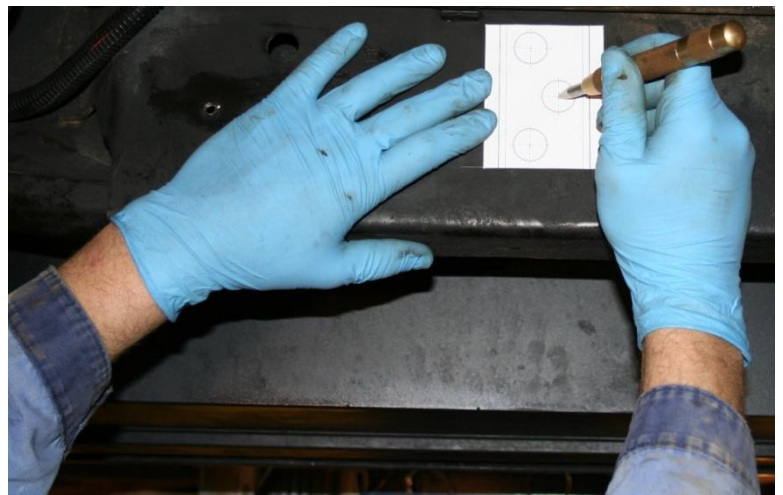
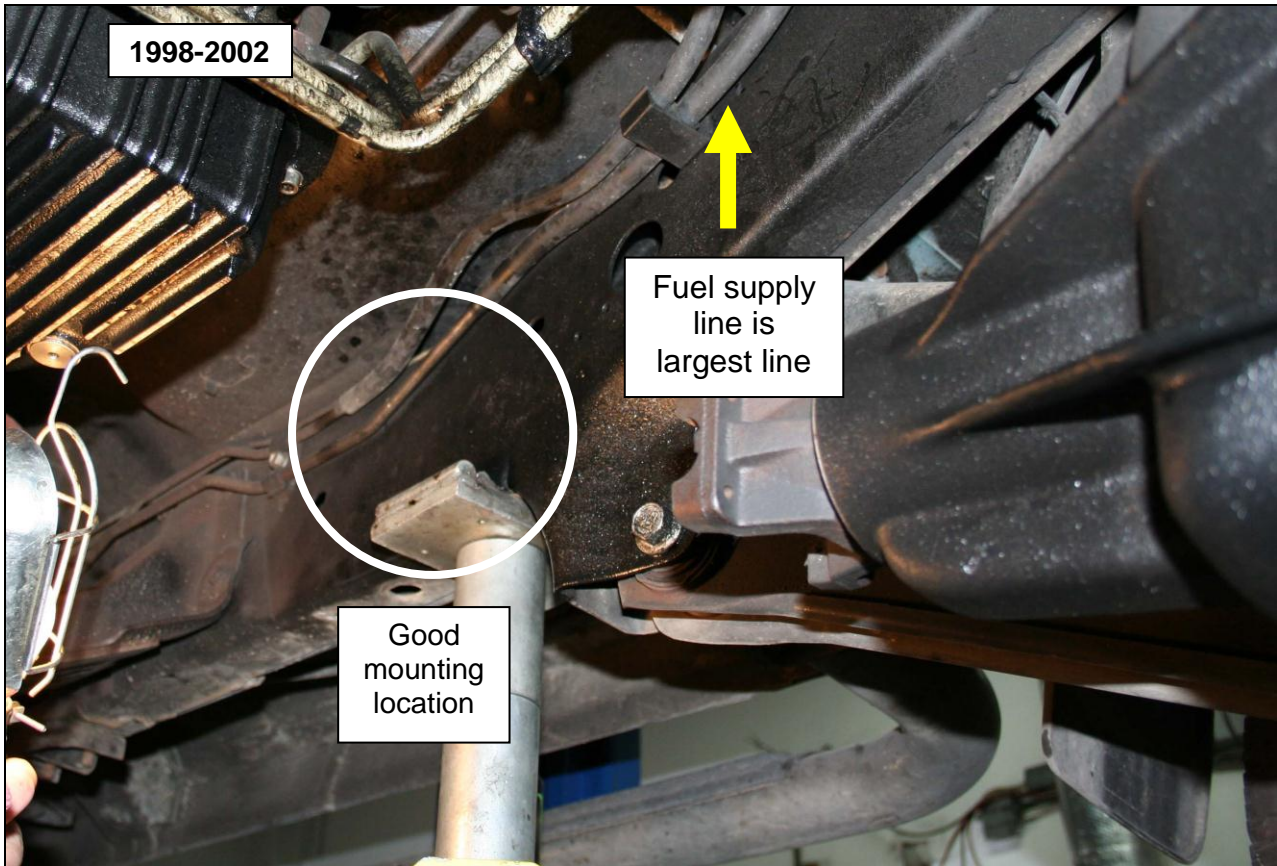

1. Center punch the three holes, remove drill template and drill a pilot hole to 1/8". Then re-drill to 11/32".

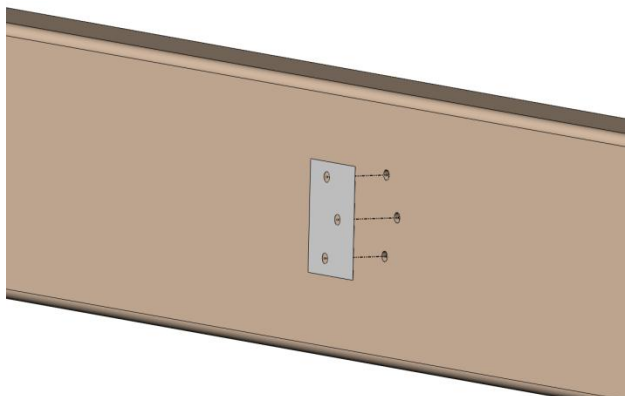

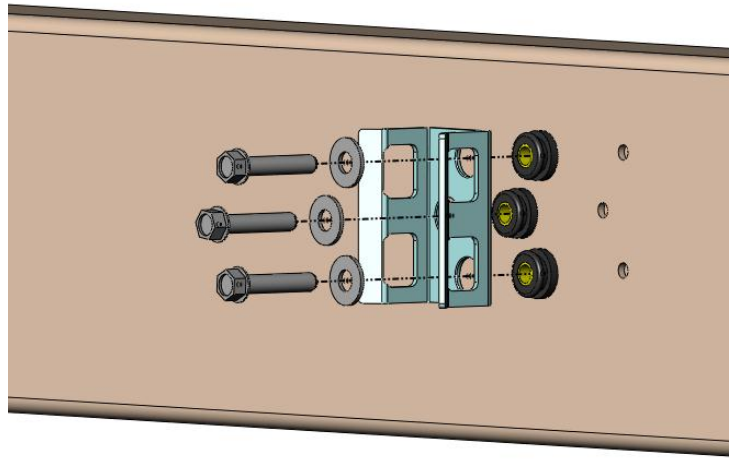

2. Insert the three rubber isolators into the support bracket. Use some water to aid in lubricating the isolators as they slide into the bracket.

Place the large washers on the inside of the bracket against the rubber isolator.

Using a air ratchet (9/16" socket) tighten the self threading 3/8" bolt through each hole of the support bracket assembly and into the frame. Repeat this step for the other 2 bolts.

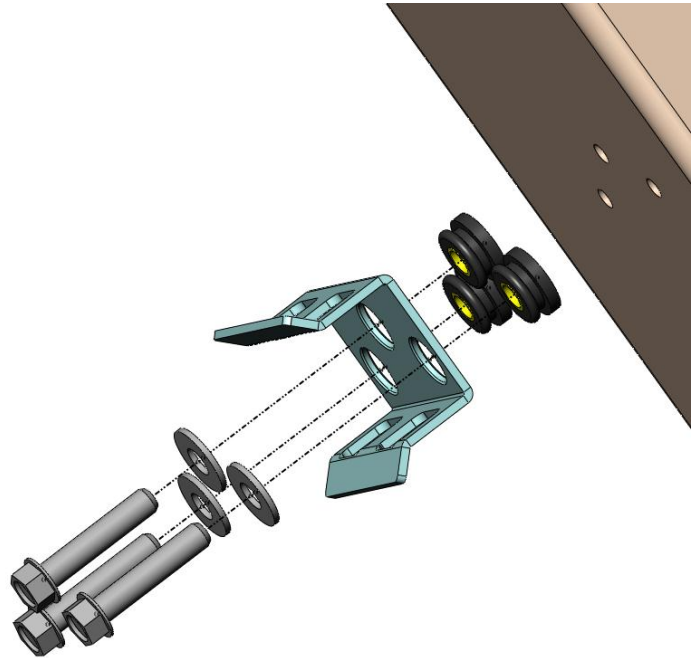

Torque the three bolts to **25ft-lbs.**

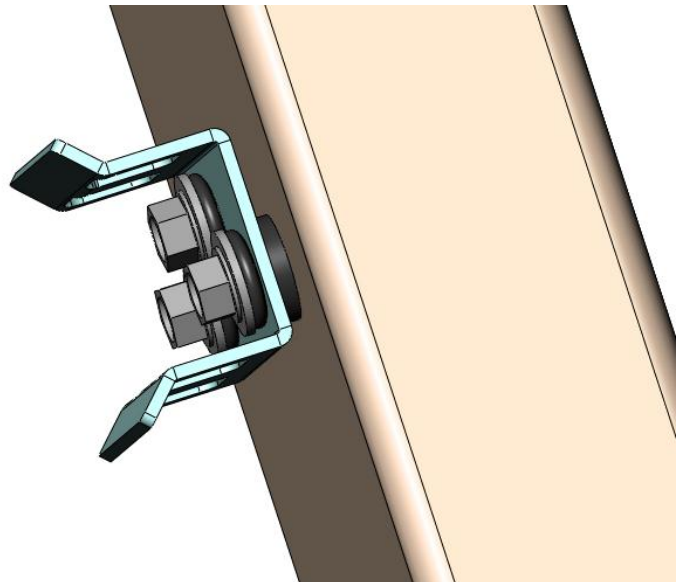

BD Engine Brake Inc.

Plant Address: 33541 MacLure Rd. Abbotsford, BC, Canada V2S 7W2

U.S. Shipping Address: 88-446 Harrison St, Sumas, WA 98295 U.S. Mailing Address: P.O. Box 231, Sumas, WA 98295

Phone: 604-853-6096 | Fax: 604-853-8749 | Internet: www.bd-power.com

3. Locate the two supplied T Bolt band clamps; unthread the nut (7/16" Socket) from each of them. Spread the clamps apart and insert them through boxed cutouts.

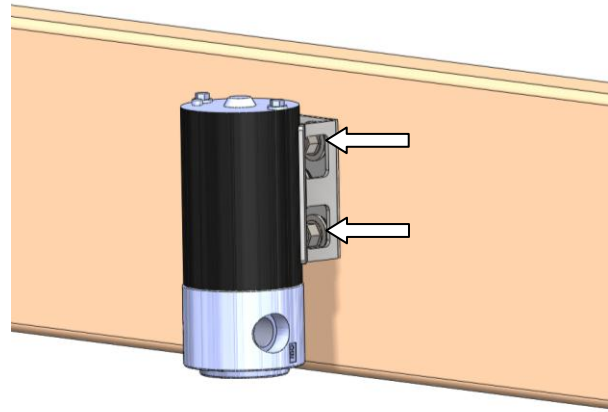

With both clamps inserted, place the pump into place and align the inlet and outlet parallel to the frame. The **inlet** should be pointed towards the fuel tank.

Tighten the clamps around the motor body, rather than the aluminum pump head. Torque nuts to **80 in-lbs.**

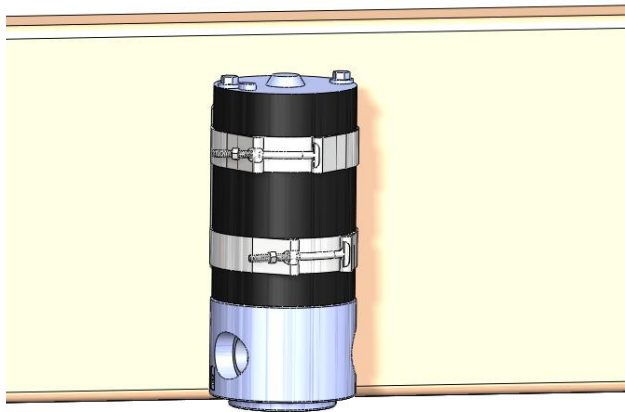

4. Insert the ORB-Barb fittings to the inlet and outlet of the pump. Do not over tighten as they use an O-ring for sealing.

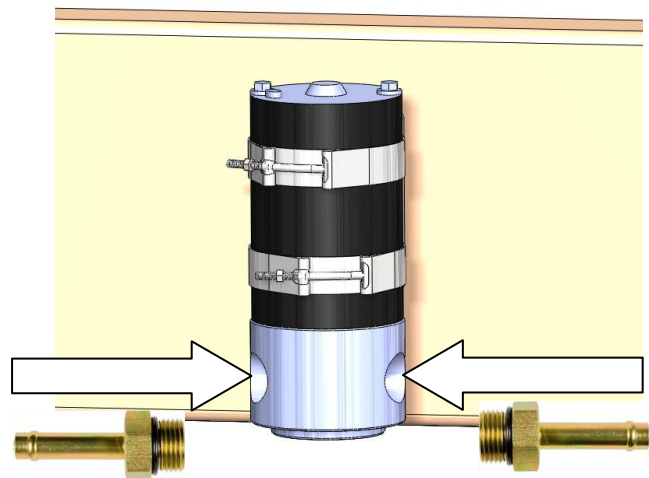

BD Engine Brake Inc.

Plant Address: 33541 MacLure Rd. Abbotsford, BC, Canada V2S 7W2

U.S. Shipping Address: 88-446 Harrison St, Sumas, WA 98295 U.S. Mailing Address: P.O. Box 231, Sumas, WA 98295

Phone: 604-853-6096 | Fax: 604-853-8749 | Internet: www.bd-power.com

5. Install the rubber hose to the inlet (IN) side of the pump with the use of one hose clamp and run the line about 5" towards the rear for the vehicle. Cut the hose at the 5"-6" length. Install supplied inline strainer with a hose clamp on each end. Continue to route the supplied fuel towards the rear of the vehicle over the skid plate. Locate a nice spot and cut the fuel supply line with respect to stock fuel line clamp and skid plate. Be sure to use a tube cutter.

****CAUTION** Diesel fuel will spill out of line when cut.**

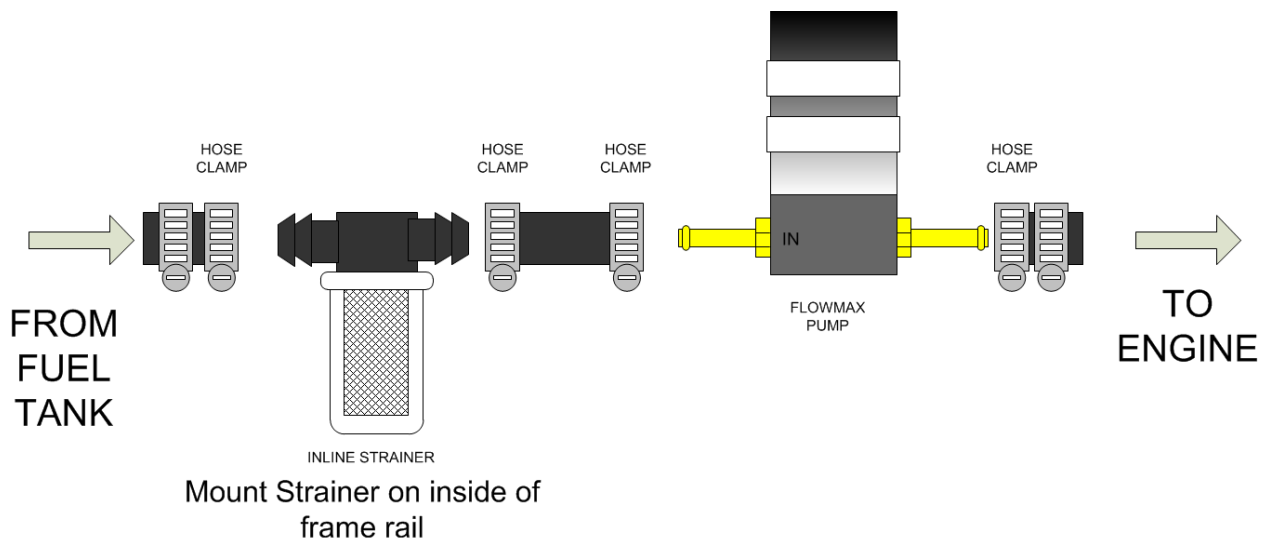

BD Engine Brake Inc.

Plant Address: 33541 MacLure Rd. Abbotsford, BC, Canada V2S 7W2

U.S. Shipping Address: 88-446 Harrison St, Sumas, WA 98295 U.S. Mailing Address: P.O. Box 231, Sumas, WA 98295

Phone: 604-853-6096 | Fax: 604-853-8749 | Internet: www.bd-power.com

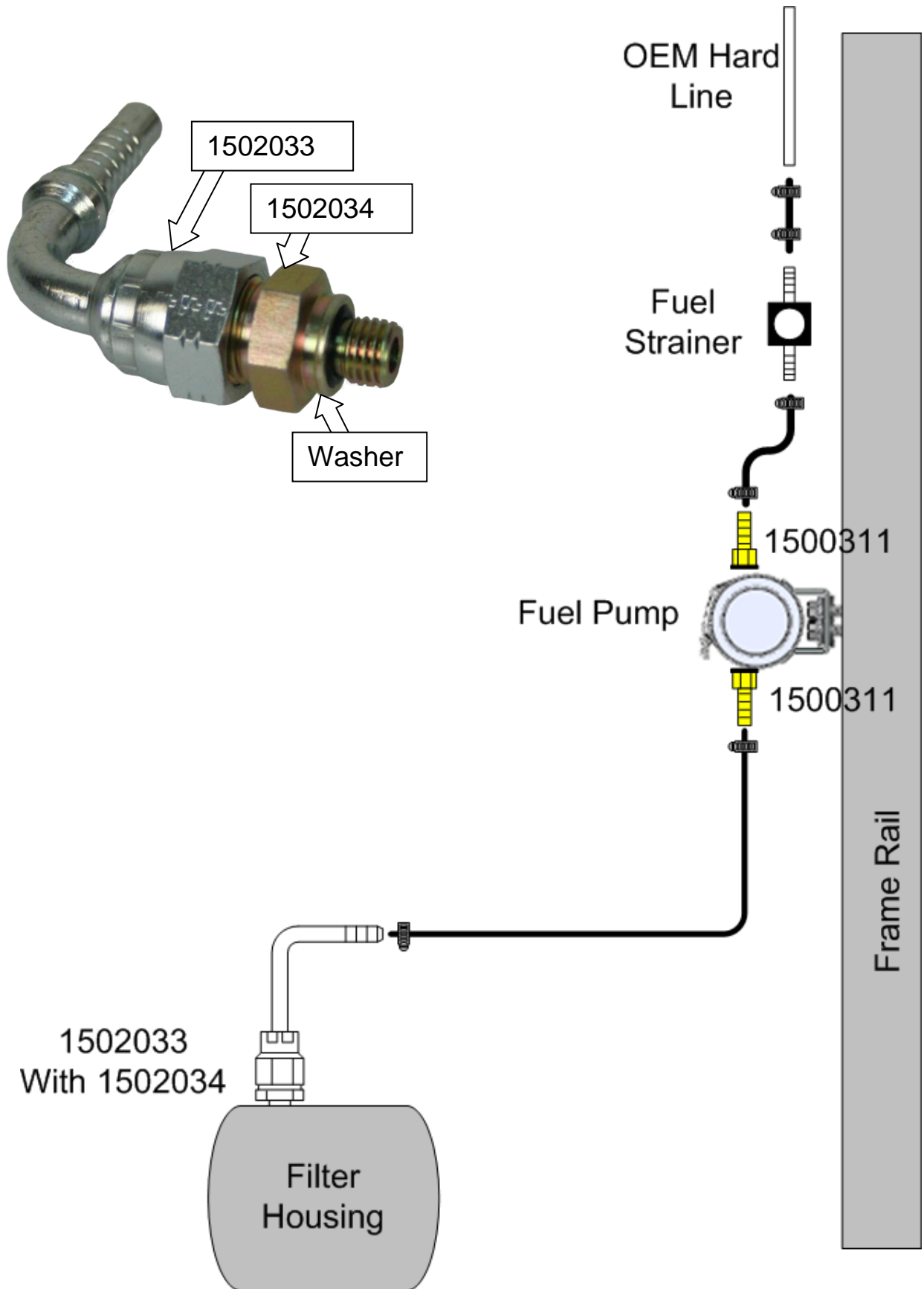

6. Remove the stock lift pump from the side of the engine along with fuel line back to where the line was cut along the frame rail and up to the fuel filter bowl. At the fuel bowl the banjo bolt will need to be removed as well since it is being replaced.

BD Engine Brake Inc.

Plant Address: 33541 MacLure Rd. Abbotsford, BC, Canada V2S 7W2

U.S. Shipping Address: 88-446 Harrison St, Sumas, WA 98295 U.S. Mailing Address: P.O. Box 231, Sumas, WA 98295

Phone: 604-853-6096 | Fax: 604-853-8749 | Internet: www.bd-power.com

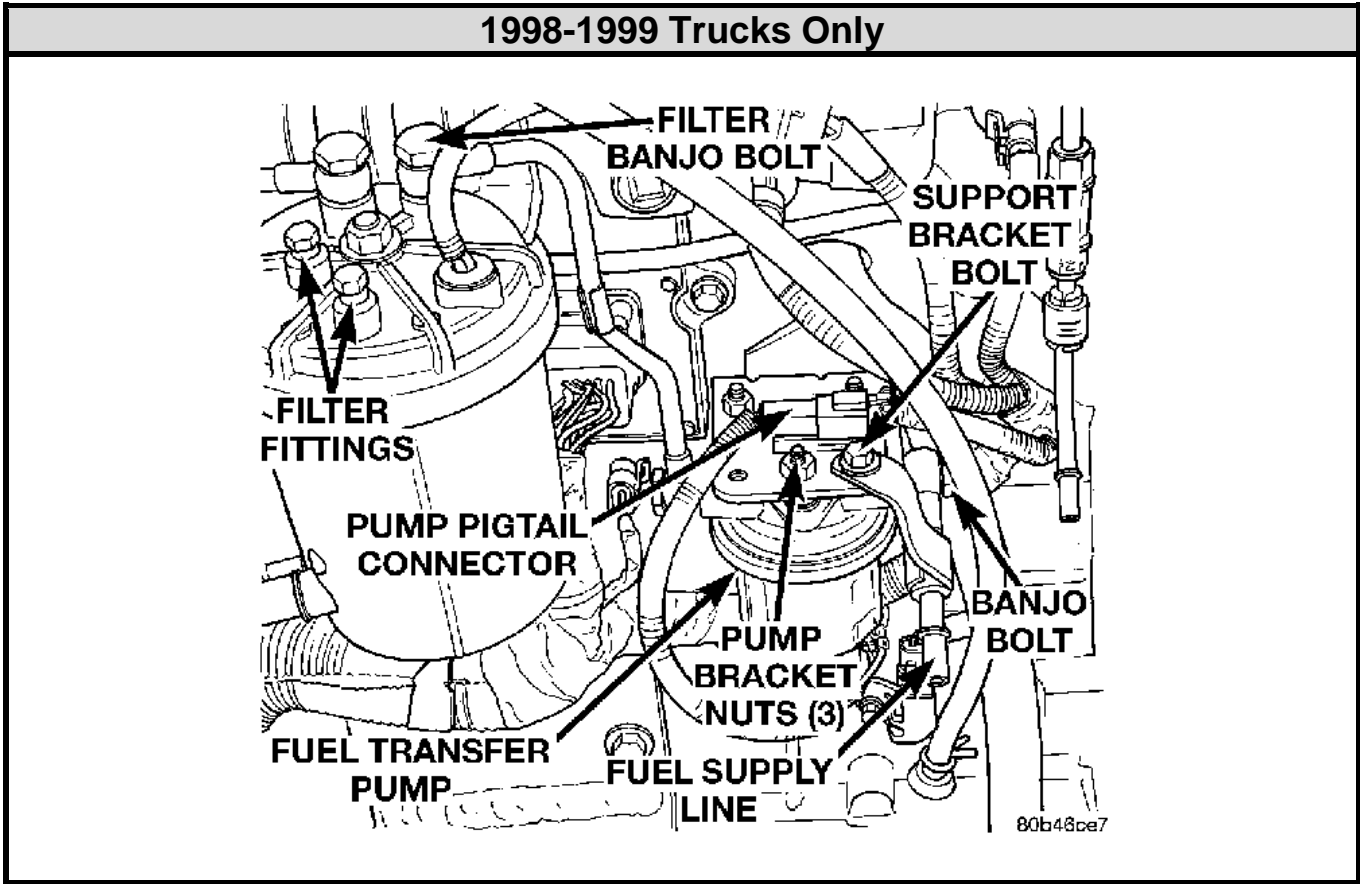

BD Engine Brake Inc.

Plant Address: 33541 MacLure Rd. Abbotsford, BC, Canada V2S 7W2

U.S. Shipping Address: 88-446 Harrison St, Sumas, WA 98295 U.S. Mailing Address: P.O. Box 231, Sumas, WA 98295

Phone: 604-853-6096 | Fax: 604-853-8749 | Internet: www.bd-power.com

2000-2002 Trucks Only

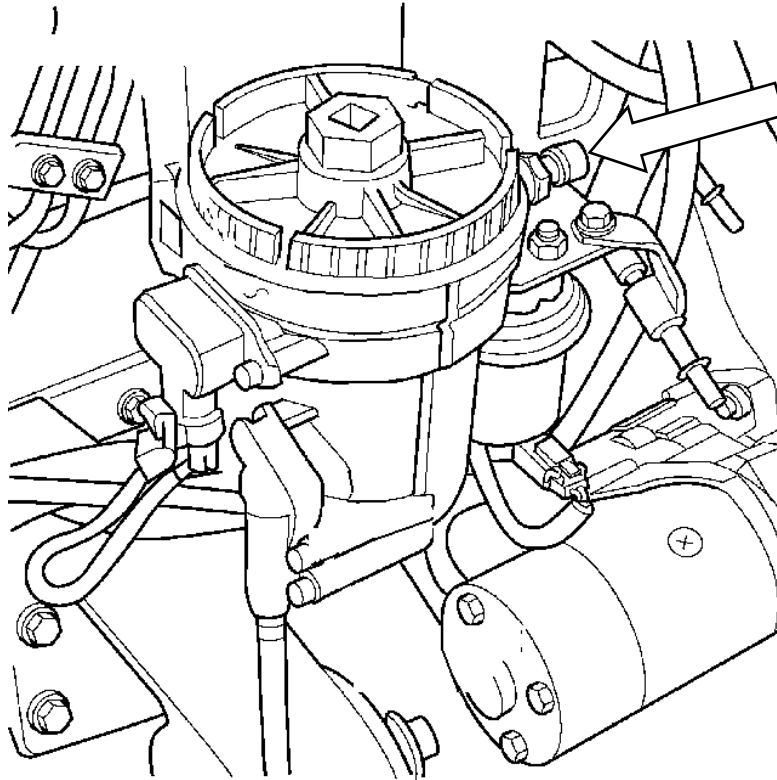

7. Thread the JICM adapter (1502033) into the fuel filter bowl and tighten first. Do not over-torque as this is an o-ring seal. Then thread on the JICF adapter (1502034) position the barbed end and tighten.

Note the JICM adapter has a loose washer around the oring ensure this does not fall off the adapter during installation. The remainder of fuel line is then run from the fuel filter bowl down to the fuel pump, with one clamp on the filter bowl adapter assembly and one on the fuel pump fitting, making sure to run the line to the outlet (OUT) side of the pump. Remove the excess fuel line prior to installing on outlet and clamping.

1998-99	Top of filter housing
2000-02	Rear of filter housing

BD Engine Brake Inc.

Plant Address: 33541 MacLure Rd. Abbotsford, BC, Canada V2S 7W2

U.S. Shipping Address: 88-446 Harrison St, Sumas, WA 98295 U.S. Mailing Address: P.O. Box 231, Sumas, WA 98295

Phone: 604-853-6096 | Fax: 604-853-8749 | Internet: www.bd-power.com

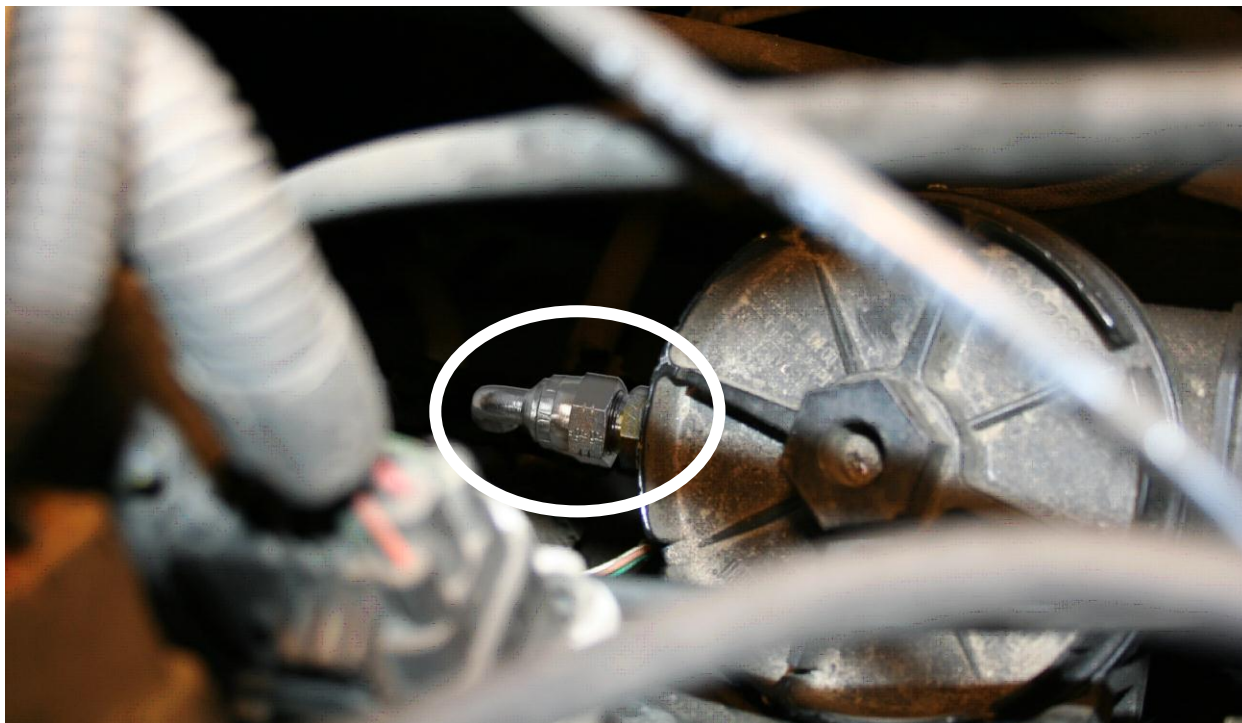

Fuel Bowl Fitting

8. Lay out the wiring harness so that it can be plugged into the stock fuel pump harness, plug into the new FlowMAX Fuel Pump, and place the positive and negative terminals in their approximate routing. Once the routing paths have been chosen and laid out, install the relay to the firewall with the use of self tapping screw.

BD Engine Brake Inc.

Plant Address: 33541 MacLure Rd. Abbotsford, BC, Canada V2S 7W2

U.S. Shipping Address: 88-446 Harrison St, Sumas, WA 98295 U.S. Mailing Address: P.O. Box 231, Sumas, WA 98295

Phone: 604-853-6096 | Fax: 604-853-8749 | Internet: www.bd-power.com



9. Wiring should be attached with the use of supplied tie wraps so that the wiring will be away from contacting hot surfaces and/or moving components. Once the wiring is attached and everything is in place the positive and negative terminals can be attached to the battery.

BD Engine Brake Inc.

Plant Address: 33541 MacLure Rd. Abbotsford, BC, Canada V2S 7W2

U.S. Shipping Address: 88-446 Harrison St, Sumas, WA 98295 U.S. Mailing Address: P.O. Box 231, Sumas, WA 98295

Phone: 604-853-6096 | Fax: 604-853-8749 | Internet: www.bd-power.com



10. Make sure that all fuel lines, wiring harness' are fixed in place well.
11. Re-install the front driveshaft (4x4 models only).
12. Lower the vehicle, and re-install the battery cables.

The pump will develop 15-18psi at idle with 14VDC. If your battery voltage is lower so will the pressure.

If you experience any problems or difficulties with this kit, please contact the BD Technical Department at 1-604-853-6096 or fax at 1-604-853-8749, between 8:00am and 4:30pm Pacific Time.



BD Engine Brake Inc.

Plant Address: 33541 MacLure Rd. Abbotsford, BC, Canada V2S 7W2

U.S. Shipping Address: 88-446 Harrison St, Sumas, WA 98295 U.S. Mailing Address: P.O. Box 231, Sumas, WA 98295

Phone: 604-853-6096 | Fax: 604-853-8749 | Internet: www.bd-power.com

Trouble Shooting

Wiring harness diagram

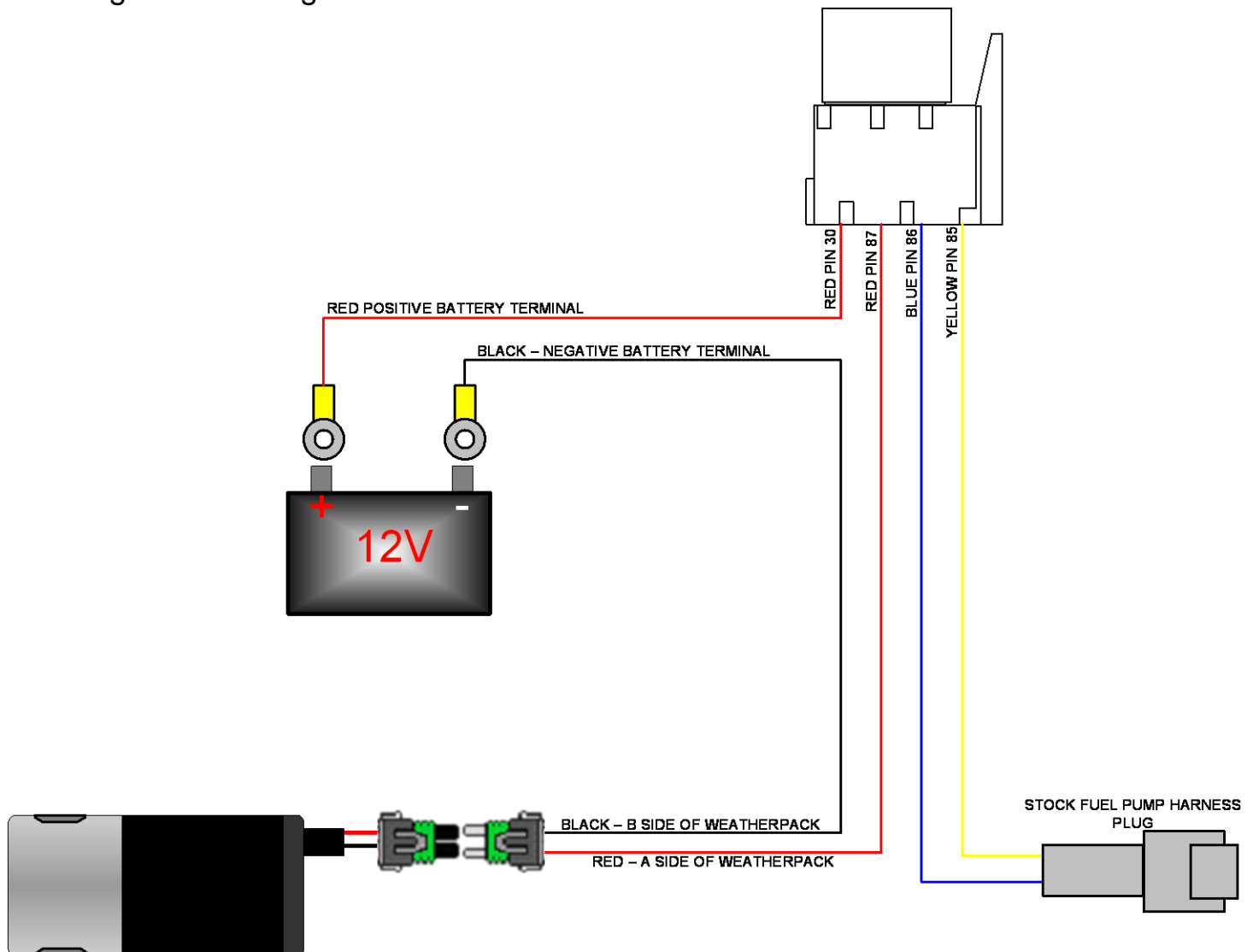

If you have problems, complete the following tests or procedures,

- Clean and re-tighten battery terminals.
- Ensure there are no crimped/pinched sections of fuel line.
- Change Fuel Filter
- Check that you have at least 12 volts at the electrical connector at the pump.
- Check that fuse in supplied harness near battery terminal is not blown.
- Check that all plugs are securely clipped together
- Run a hose from a fuel can full of diesel to the pump inlet to see if the pressure changes.

If the pressure increases the problem is a restriction in the line possibly a clogged fuel screen.

The pump should operate between 16 and 18psi with 14V at idle. If you have lower voltage, then the pump pressure will also be lower.

BD Engine Brake Inc.

Plant Address: 33541 MacLure Rd. Abbotsford, BC, Canada V2S 7W2

U.S. Shipping Address: 88-446 Harrison St, Sumas, WA 98295 U.S. Mailing Address: P.O. Box 231, Sumas, WA 98295

Phone: 604-853-6096 | Fax: 604-853-8749 | Internet: www.bd-power.com