



BD SUPER "B" SINGLE TURBO KIT ***1994-2002 Dodge 24v ISB***

Part #: 1045220

PLEASE READ ALL INSTRUCTIONS BEFORE INSTALLATION

UNLESS AN EO# IS LISTED, THIS PRODUCT IS LEGAL IN CALIFORNIA FOR RACING VEHICLES ONLY, WHICH MAY NEVER BE USED UPON A HIGHWAY.

BD ENGINE BRAKE, INC.





Plant Address: A10-33733 King Rd, Abbotsford, BC, Canada V2S 7M9

US Shipping Address: 88-446 Harrison St, Sumas, WA 98295 US Mailing Address: PO Box 231, Sumas, WA 98295

Phone: 604-853-6096 Fax: 604-853-8749 Internet: www.bd-power.com

K I T C O N T E N T S :

Please check to make sure that you have all the parts listed in this kit **before** you start the disassembly your truck.

DODGE 1994-2002 "SUPER B" SINGLE TURBO KIT (BD# 1045220)			
1405215	1405926	1045927	1100740
			
<i>Super "B" Single Turbo</i>	<i>Turbo Clamp</i>	<i>4" Down Pipe</i>	<i>4" Stainless Steel Down Pipe Clamp</i>
Qty: 1	Qty: 1	Qty: 1	Qty: 1

24V Installations
1405986

Manifold bolt M10x1.5x45
Qty: 2

Pre-Installation Notes

A turbocharger is driven solely on exhaust energy. Therefore, if the vehicles current exhaust manifold is cracked or is leaking, it is recommend that new exhaust gaskets and a heavy-duty exhaust manifold be used.

Installation should occur on a cold vehicle, as turbo and exhaust components become very hot with use.

The BD Super B system is recommended for trucks with 300-400 RWHP with a maximum efficient boost pressure of 45psi. For optimum performance, the turbo should operate between 37–45psi.

UPGRADE OPTIONS

<u>Description</u>	<u>Part #</u>
BD 'X' Torque Converter	1070215X
BD Transmission	CALL
BD High Flow Injectors	CALL
BD Lift pump kit 24V	1050226
BD High Flow Banjo Bolts 24V	10502XX
Heavy Duty Exhaust Manifold 24V	1045985
Heavy Duty Exhaust Manifold 12V	1045980
BD X2 Digital Gauge Monitor	1080500
BD High Pressure Intercooler Boots	1405220
BD Cool Down Timer 2	1081160

If you are installing a BD Engine Brake with this turbo you will require:

(1) Turbo Plate PN# 1453238

(5) M8-1.25 x 20mm bolts

Reuse the existing (5) hardened M8 washers.

BD ENGINE BRAKE, INC.

Plant Address: A10-33733 King Rd, Abbotsford, BC, Canada V2S 7M9

US Shipping Address: 88-446 Harrison St, Sumas, WA 98295 US Mailing Address: PO Box 231, Sumas, WA 98295

Phone: 604-853-6096 Fax: 604-853-8749 Internet: www.bd-power.com

BATTERY DISCONNECT

Disconnect the negative terminals on both of the vehicle's batteries, and then disconnect the positive terminals.

INSTALLATION

Record radio settings and disconnect both battery terminals on both batteries.

Lay a protective cover over the passenger side fender to eliminate any scratches.

Remove the air box assembly and intake tube from inlet of turbocharger.

Remove the two 13mm bolts connecting the exhaust down pipe to the turbo flange.

Remove the v-band clamp on the turbo compressor-housing outlet that connects to the intercooler. Be sure not to lose the orange o-ring from the intercooler inlet tube elbow. Also make sure that you cover the intercooler tube so debris does not fall inside.

Remove the turbo oil feed line and un-bolt the turbo oil drain tube and cover the inlet to protect it from contamination.

Remove the four nuts holding the turbo to the exhaust manifold. Remove the stock turbo and set it aside.

Inspect the exhaust manifold for shrinkage, cracks and leaks. If none are found, remove the original turbo gasket and clean the turbo-mating surface. If any cracks are found, you will need to replace the manifold with a stock replacement or a heavy-duty aftermarket version.

Remove the turbo down pipe. Note that it is assumed that the user has a full 4" exhaust system at the time of install, not a CAT-Back system or stock exhaust.

Remove the original gasket from the oil drain tube sealing flange and replace with the new gasket provided.

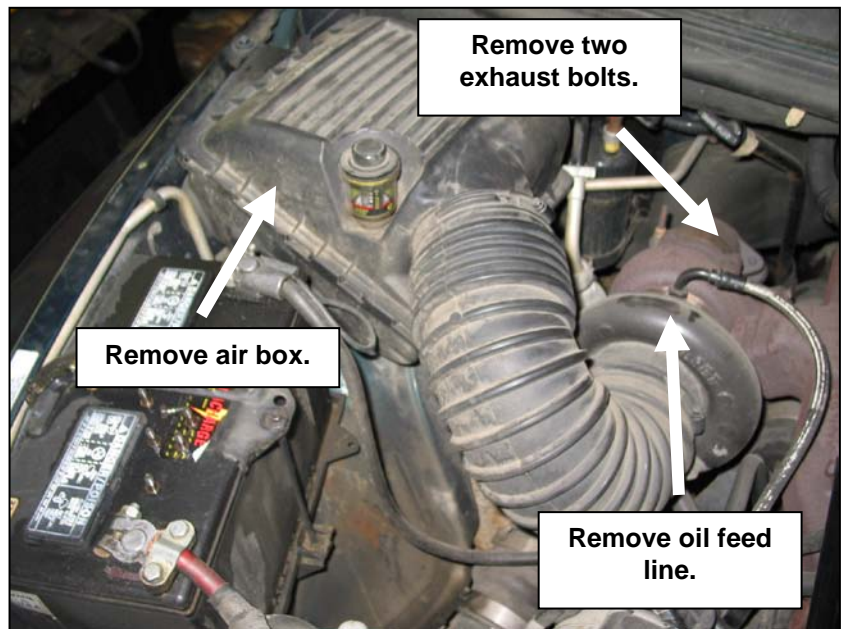

BD ENGINE BRAKE, INC.

Plant Address: A10-33733 King Rd, Abbotsford, BC, Canada V2S 7M9

US Shipping Address: 88-446 Harrison St, Sumas, WA 98295 US Mailing Address: PO Box 231, Sumas, WA 98295

Phone: 604-853-6096 Fax: 604-853-8749 Internet: www.bd-power.com

Install the "Super B" turbo with the supplied gasket and the four factory nuts (gasket direction is unimportant) to the exhaust manifold. Torque to 24 ft lbs. For 24V installations two M10x1.5x45mm bolts have been provided.

TURBO CLOCKING/ALIGNING (If Necessary)

Loosen the four bolts clamping the exhaust housing to the turbo body and rotate body until oil feed drains are straight up and down. Re-tighten the four bolts. Loosen the eight bolts clamping the turbo compressor housing to the body and rotate housing to align with intercooler tube. You need to align the compressor outlet to the stock cast aluminum elbow with the orange o-ring in it. Now tighten the eight bolts holding the compressor housing to the body to secure its position.

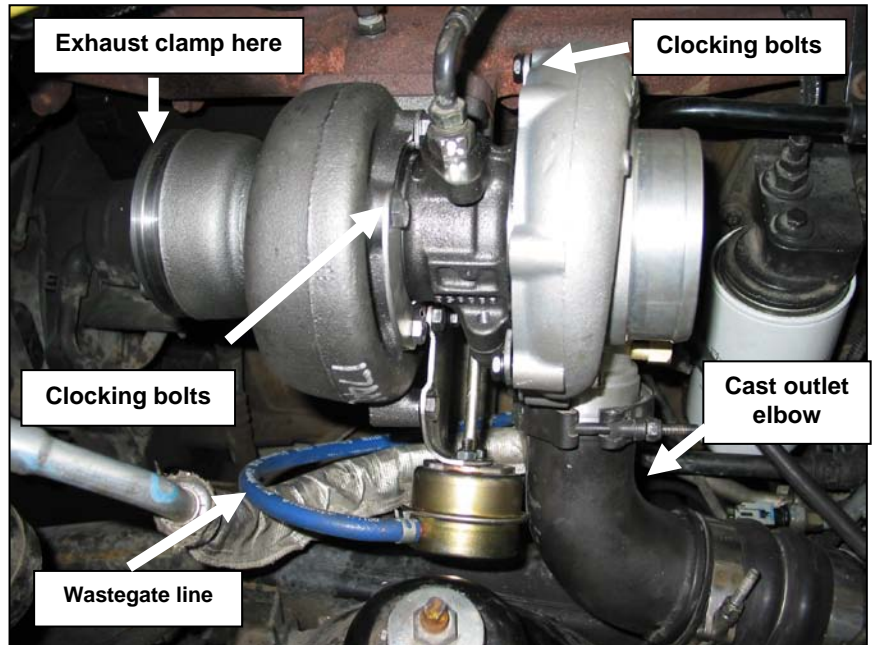

Ensure the orange o-ring is in place and use the factory v-band clamp to connect to compressor housing to the intercooler elbow and tube. Adjustment of the first intercooler boot may be required for a proper fit.

Connect the oil drain tube to the bottom of the turbo using the supplied gasket and the original hardware. You will need to slide the oil drain adapter as far as possible away from the wastegate arm to prevent any contact. In some rare cases the wastegate arm may need to be bent.

Be sure to squirt fresh oil down the oil feed port while rotating the compressor wheel. This will ensure a smooth start-up and reduce the chance of damaging the bearings.

Remove the oil feed line adapter from stock turbo and install in the "Super B" turbo. Be sure to inspect the adapters o-ring for any damage to reduce the chance of an oil leak. Install the oil feed line.

Ensure the brass barb fitting in the compressor housing is tight and install blue rubber wastegate hose and clamp the end to the wastegate.

Install the new down pipe to the rear of the turbo. It is highly recommended to loosely clamp all exhaust pieces together to ensure proper fit before tightening anything. Position all exhaust clamps $\frac{1}{4}$ " from joints and if possible tack weld all pipes to prevent twisting.

BD ENGINE BRAKE, INC.

Plant Address: A10-33733 King Rd, Abbotsford, BC, Canada V2S 7M9

US Shipping Address: 88-446 Harrison St, Sumas, WA 98295 US Mailing Address: PO Box 231, Sumas, WA 98295

Phone: 604-853-6096 Fax: 604-853-8749 Internet: www.bd-power.com

You can now install the factory air box and intake tube. Double check all clamps to ensure they are tight.

Reconnect negative battery terminals and start the vehicle. Check for any exhaust or oil leaks.

Take it easy on the turbo for the first 100 miles to allow a proper break-in period. Be very cautious of any unusually sounds or leaks during this time.

Note: The exhaust housing of the turbo may smoke when new as manufacturing residue on housing must burn off.

IMPORTANT When idled for any length of time some oil may leak from the turbo. If the performance/boost is satisfactory and the wheel is not touching the housing (There will be some small movement), the excess oil is not a concern. Simply wipe with a clean cotton cloth and continue use.

1994-95 Trucks

When installing the turbo on 1994-95 trucks you will need to remove the steel wastegate line that is connected to the factory turbo and the AFC housing of the P7100 fuel injection pump.

With this line disconnected you will need to plug off the connection point at the AFC housing with a 1/8" NPT plug.

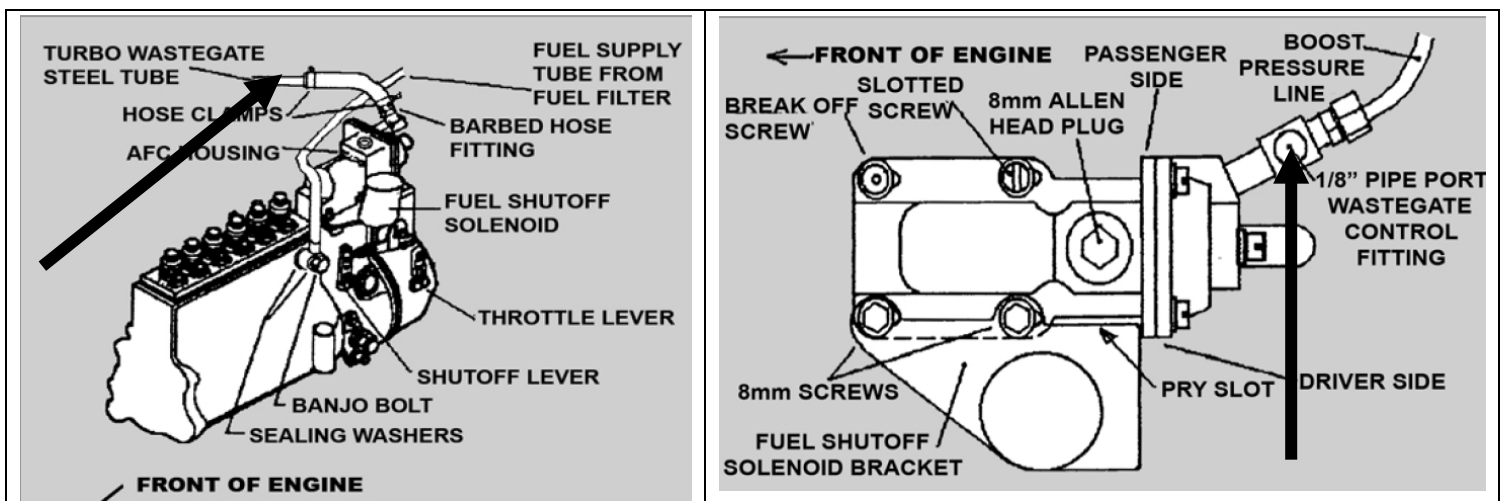

BD ENGINE BRAKE, INC.

Plant Address: A10-33733 King Rd, Abbotsford, BC, Canada V2S 7M9

US Shipping Address: 88-446 Harrison St, Sumas, WA 98295 US Mailing Address: PO Box 231, Sumas, WA 98295

Phone: 604-853-6096 Fax: 604-853-8749 Internet: www.bd-power.com