



X Flow Intake Manifold

For 2003-07 Dodge 5.9L Cummins Trucks

Part #	Description
1041555	Intake Horn (Black Powder Coat)
1041555-P	Intake Horn (Polished Aluminum)

-- Installation Instructions --
 PLEASE READ ALL INSTRUCTIONS CAREFULLY BEFORE INSTALLATION.











UNLESS AN EO# IS LISTED, THIS PRODUCT IS LEGAL IN CALIFORNIA FOR RACING VEHICLES ONLY, WHICH MAY NEVER BE USED UPON A HIGHWAY.

BD Engine Brake Inc.

Plant Address: 33541 MacLure Rd. Abbotsford, BC, Canada V2S 7W2

U.S. Shipping Address: 88-446 Harrison St, Sumas, WA 98295 U.S. Mailing Address: P.O. Box 231, Sumas, WA 98295
 Phone: 604-853-6096 | Fax: 604-853-8749 | Internet: www.bd-power.com

Kit Contents

1041555 (Black) and/or 1041555-P (Polished) Dodge X-Flow Intake			
1401555	1401555-POL	1401551Z	1401552Z
			
<i>Powder Coated Intake</i> 1041555 Kit ONLY	<i>Polished Manifold</i> 1041555-P Kit ONLY	<i>Long Stud</i>	<i>Short Stud</i>
Qty: 1	Qty: 1	Qty: 2	Qty: 2
1401553	1401554	1401556	3969988
			
<i>M8 JIS Flange Nut</i>	<i>M8 Acorn Nut</i>	<i>M8 Washer</i>	<i>Intake Gasket</i>
Qty: 2	Qty: 2	Qty: 2	Qty: 1
1130055	1200208		
			
<i>Jam Nut</i>	<i>1/8" NPT Plug</i>		
Qty: 1	Qty: 2		

Installation

Remove the factory intake elbow, and remove the silicon boot hose clamp with a 7/16" wrench. Use a 10mm socket to remove the oil dipstick mount. Be sure to save this bolt as it will be re-used later.

You can also remove the four other mounting bolts that secure the intake manifold in place.

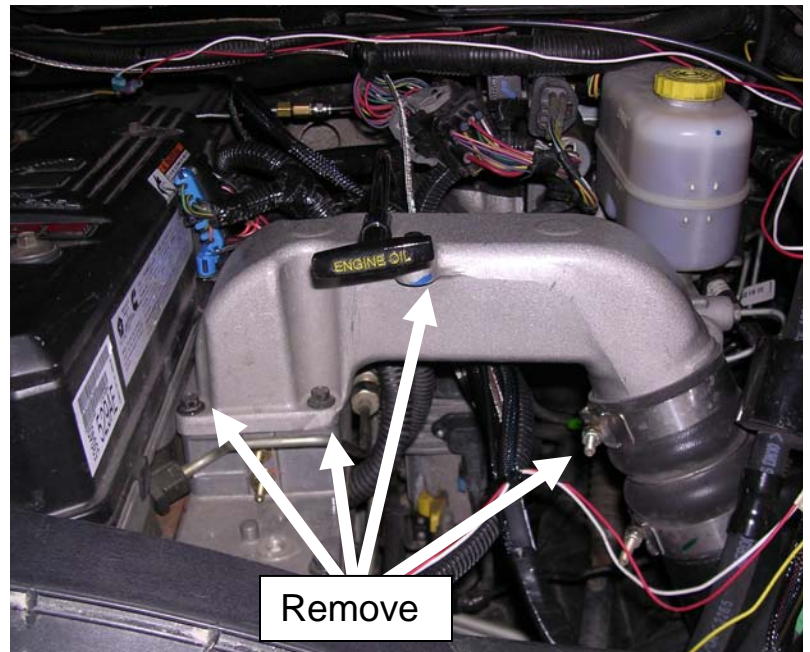

On the rear of the intake you will notice a wiring harness bolted to the intake. You will need to remove the nut and washer that secure the wiring harness to the intake.

You can now lift and remove the intake elbow.

With the intake elbow now out of the truck, remove the wiring harness mounting stud and install it into the BD intake elbow.



BD Engine Brake Inc.

Plant Address: 33541 MacLure Rd. Abbotsford, BC, Canada V2S 7W2

U.S. Shipping Address: 88-446 Harrison St, Sumas, WA 98295 U.S. Mailing Address: P.O. Box 231, Sumas, WA 98295

Phone: 604-853-6096 | Fax: 604-853-8749 | Internet: www.bd-power.com

You will now need to scrape off any left-over gasket material that resides on the intake heater.

Be sure that no media falls into the intake.

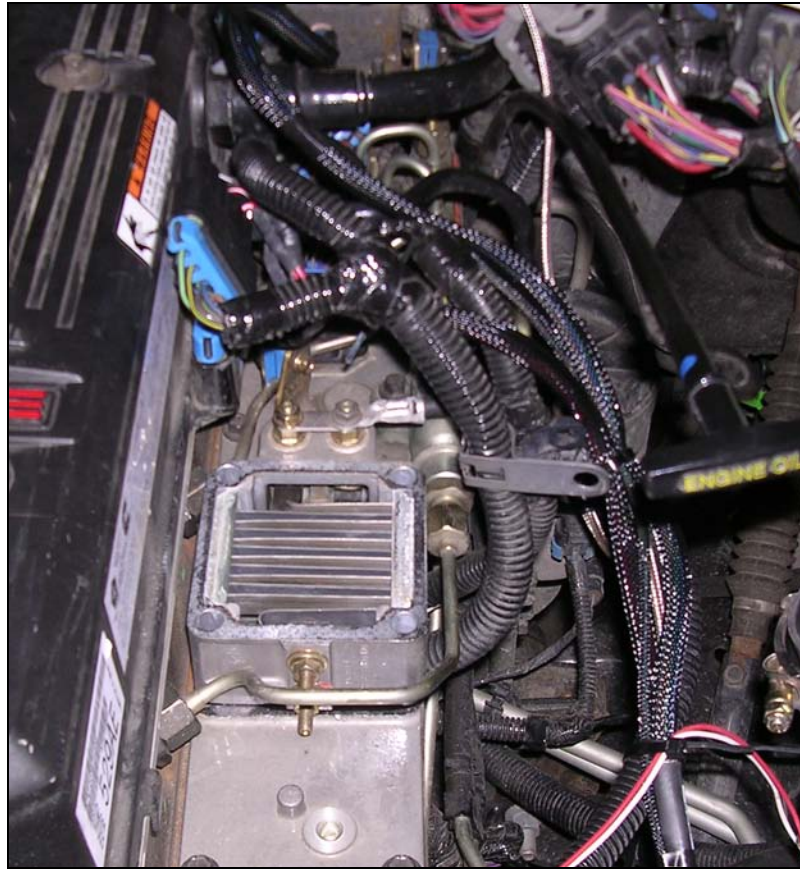

Place the new gasket (supplied) in place on top of the intake heater.

You can now thread in the mounting studs. The long studs are mounted in the threaded holes closest to the valve cover. Note that before installing these studs you will need to cover the studs with pipe dope or another thread sealer.

Install the shorter studs in the two remaining threaded holes.



BD Engine Brake Inc.

Plant Address: 33541 MacLure Rd. Abbotsford, BC, Canada V2S 7W2

U.S. Shipping Address: 88-446 Harrison St, Sumas, WA 98295 U.S. Mailing Address: P.O. Box 231, Sumas, WA 98295
Phone: 604-853-6096 | Fax: 604-853-8749 | Internet: www.bd-power.com

With the jam nut supplied you will need to double nut each stud and torque the stud down in place to 3 lbs-ft. You must make sure that the threads are fully seated in place. Once it has been torqued, you can remove the two nuts.

Note that the end with the shorter length of thread, should be inserted into the head.

With the studs torqued, it is suggested that you unplug the fuel pressure sensor and the wiring harness for the injectors on cylinders 3 & 4. This should allow a little more room.

To ease the installation, you can remove the mounting bolt that secures the dipstick tube in place to the engine block. It is located about 24" from the front of the tube.

Drop the BD intake manifold in place over the studs. You may need some assistance in moving the dipstick out of the way.

Before installing the elbow in place, you can thread in the supplied 1/8" NPT plug, or, install the boost pressure line in its place.



Tighten the Acorn nut onto the jam nut.

BD Engine Brake Inc.

Plant Address: 33541 MacLure Rd. Abbotsford, BC, Canada V2S 7W2

U.S. Shipping Address: 88-446 Harrison St, Sumas, WA 98295 U.S. Mailing Address: P.O. Box 231, Sumas, WA 98295
Phone: 604-853-6096 | Fax: 604-853-8749 | Internet: www.bd-power.com

Move the intake around so that it is not touching anything and secure the intake with the supplied nuts. Note that the 12mm JIS nuts should be mounted to the smaller studs on the driver's side of the intake, while the 13mm Acorn nuts should be mounted to the longer studs. Be sure to place the washers underneath the Acorn nuts.

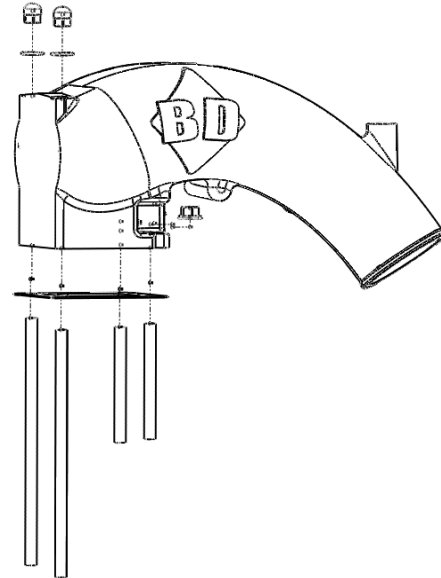

Torque the nuts to **13 ft-lbs**.

Reuse the factory dipstick tube mounting bolt to secure the dipstick to the intake.

Reconnect the wiring harnesses from the fuel pressure sensor and the injectors. You can secure this wiring harness to the factory mounting stud. You will need to re-use the washer and nut that you removed earlier.

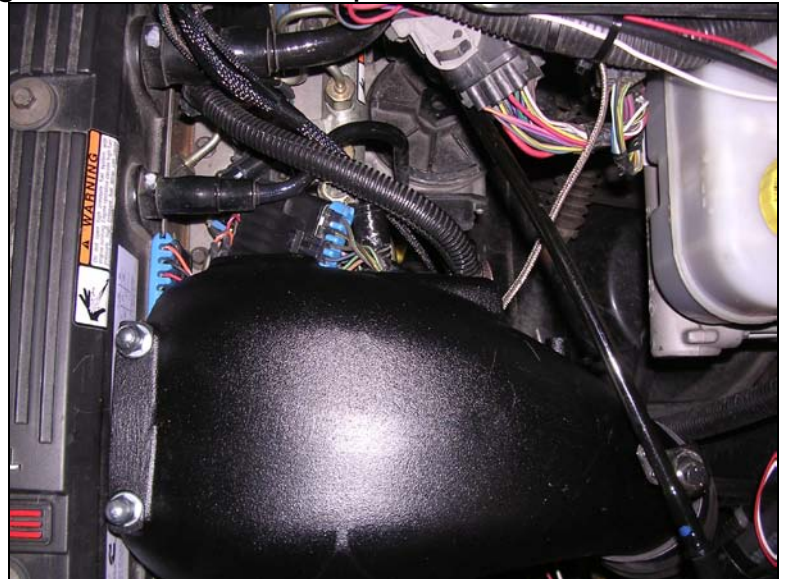

You can now reconnect the factory silicone boot and clamp. Be sure to clean the inside of the silicone boot with either a non oil based electrical contact cleaner or brake clean.

BD Engine Brake Inc.

Plant Address: 33541 MacLure Rd. Abbotsford, BC, Canada V2S 7W2

U.S. Shipping Address: 88-446 Harrison St, Sumas, WA 98295 U.S. Mailing Address: P.O. Box 231, Sumas, WA 98295
Phone: 604-853-6096 | Fax: 604-853-8749 | Internet: www.bd-power.com