



48 RE Pressure Enhancer









For 2005-2007 Dodge Ram Diesel Trucks

P/N# 1030348

PLEASE READ ALL INSTRUCTIONS BEFORE INSTALLATION

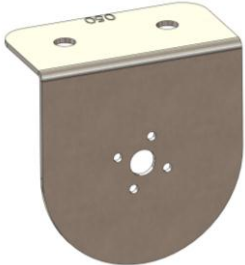
KIT CONTENTS:

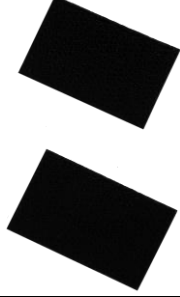
Please check to make sure that you have all the parts listed in this kit **before** you start the disassembly of your truck.

1330048	1000349	1300131	1800060
			
<i>Trans Shifter Module & Switch Assy</i>	<i>Decal</i>	<i>Cable Ties</i>	<i>Velcro Strips</i>
Qty: 1	Qty: 1	Qty: 8	Qty: 2 x 4"
1330050	1330052	1330051	1330053
			
<i>Switch Bracket</i>	<i>Screw</i>	<i>Switch Bracket Velcro</i>	<i>Alcohol Swab</i>
Qty: 1	Qty: 2	Qty: 2 x 1.5"	Qty: 1

Required Tools

- Utility Knife
- Side Cutter
- Pick Tool or Small Flat Screw Driver
- 7 mm Socket
- 5/16" Socket
- Philips Screwdriver
- 5/16", 1/2" Wrench
- 1/16" & 1/4" Drill Bits
- Drill
- 1/16" Allen Wrench

BD Engine Brake Inc.

Plant Address: 33541 MacLure Rd. Abbotsford, BC, Canada V2S 7W2

U.S. Shipping Address: 88-446 Harrison St, Sumas, WA 98295 U.S. Mailing Address: P.O. Box 231, Sumas, WA 98295

Phone: 604-853-6096 | Fax: 604-853-8749 | Internet: www.bd-power.com

Welcome

Thank you for purchasing your 48 RE Pressure Enhancer. This manual is divided into different areas to assist you with the installation and operation of your Pressure Enhancer.

Installation should occur on a vehicle properly secured to prevent rolling.

Mode / Position	Use
1	Light Towing
2	Medium Towing / Performance Mode
3	Performance / Race Mode

Please note on some vehicles the higher positions may result in an unusual light throttle shift automatically. Although not dangerous to the transmission, the next lower level should be used.

INSTALLATION



VEHICLE SHOULD BE SAFELY SECURED BEFORE INSTALLATION.

1. Block vehicle wheels to prevent rolling and disconnect the negative battery terminals.
2. Using the supplied Velcro mount module in a secure location near the driver's side battery.



3. Route TTVA plug connectors down the firewall and under the vehicle.
4. Disconnect transmission harness by sliding the red locking tab out and pressing behind the tab to release the connector from the TTVA motor then connect the shift enhancer harness to TTVA motor and the transmission harness.

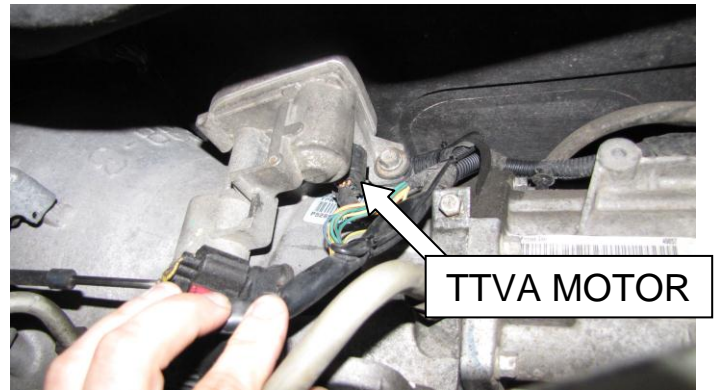

5. Cable tie wiring along transmission across to the frame rail and up the firewall.

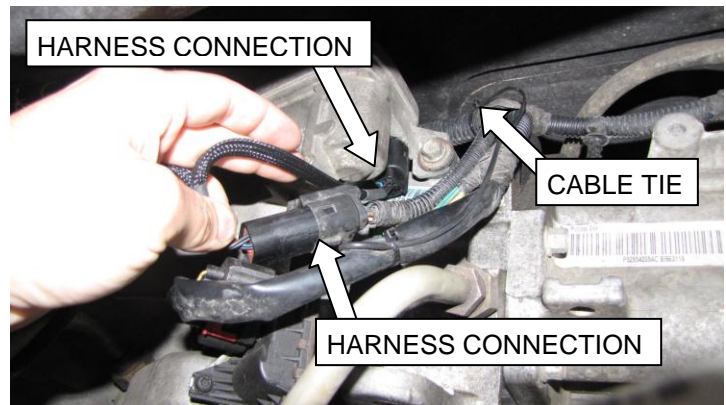

6. Remove lower dash panel and route switch harness from steering column area through grommet in firewall and connect into module harness.
(7 mm Socket or Philips Screw Driver)

NOTE: Routing the harness through the plastic cap via a drilled hole instead of the grommet is also an option. Ensure the area behind the drilled hole location is clear.

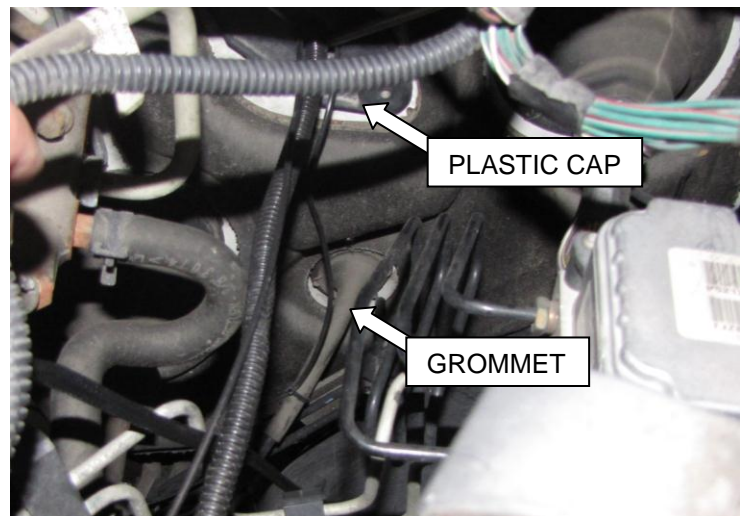

Methods for mounting the switch to the dash

Mounting Switch with Bracket

7. **Velcro:** To mount the switch bracket using the 3M dual lock. Prep both surfaces with the supplied alcohol swab. Then remove backing from dual lock and press firmly, one onto the dash location and one onto the switch bracket mounting surface.

OR

Screws: The switch bracket can also be mounted using the supplied self-tapping screws with a 5/16" socket.

Note the plate can be mounted to the dash in four positions to accommodate any location. Skip to step 10 for mounting the switch.

Warning: Before mounting the plate to the dash ensure the area behind the dash is clear.

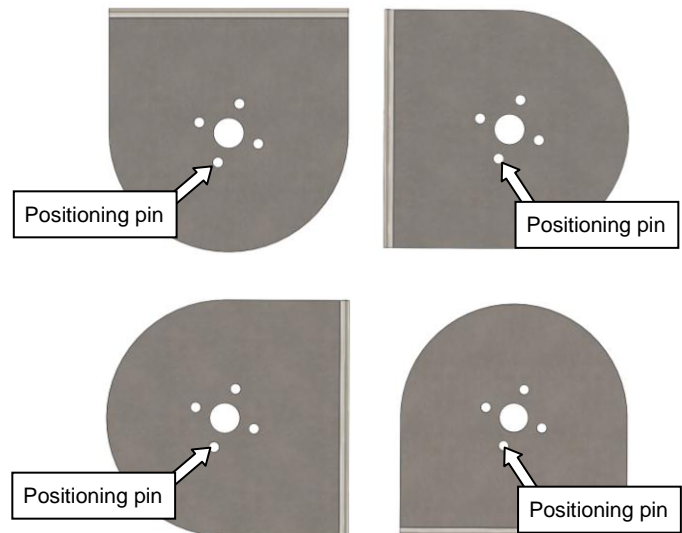
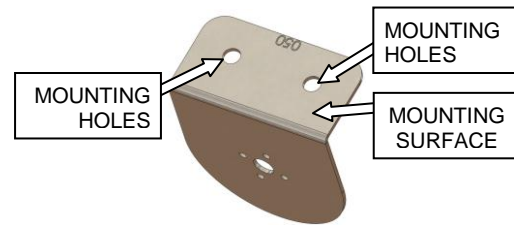

Mounting switch into dash

8. Using the decal/template find a suitable location to mount switch within the reach of the driver.

Important: Check behind panel for proper clearance before drilling.



9. Using the decal as a drill template you can now drill a 1/4 hole for the main part of the switch and a 1/16 hole for the locator nub.

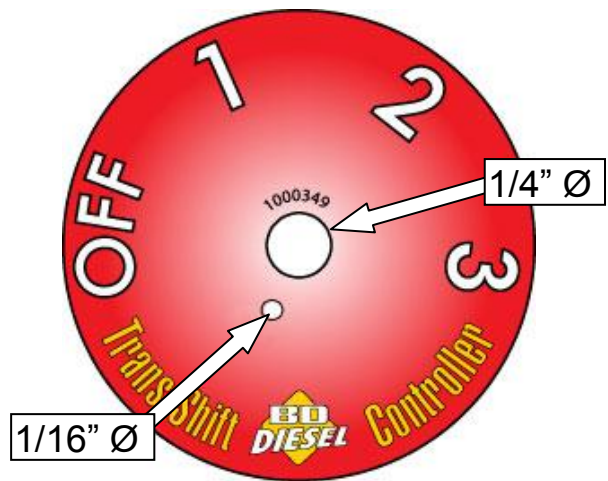

10. Mount switch.

NOTE: You can use side cutters or an angle grinder to shorten the switch shaft if it is too long.

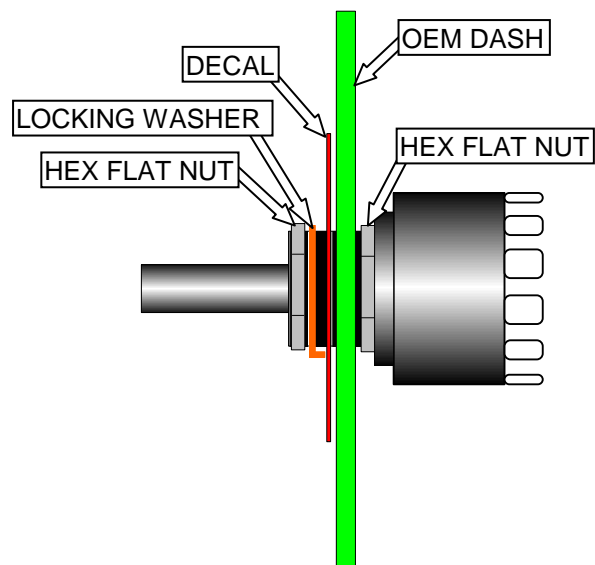

11. Mount the knob using a 1/16" Allen wrench.

IMPORTANT: The set screw on the right side should fasten to the flat spot on the switch shaft to align the knob line to the decal marks.

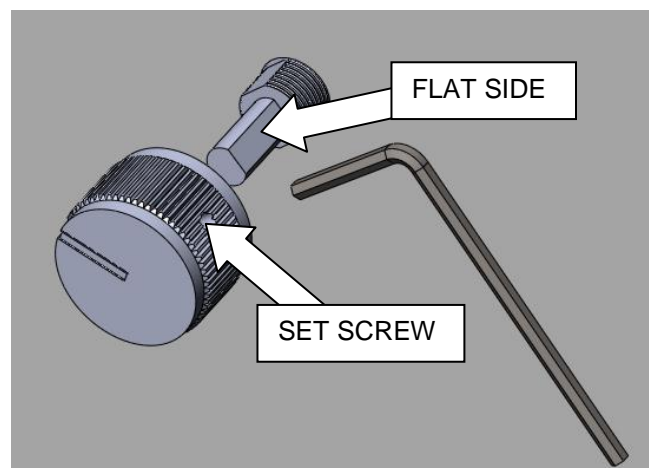

If you have any technical difficulties, concerns, comments, or complaints, please phone our Technical Support hotline at (800) 887-5030 between

8:30am-5:00pm PST (Pacific Standard Time) Monday to Friday, or post a message on the BD Discussion Forums located at:

<http://forum.bd-power.com/>



Visit our Internet forums at <http://www.dieselpower.com> and share your comments or technical support questions with some of the industry's leading experts in the diesel field.

BD ENGINE BRAKE, INC.

Plant Address: A10-33733 King Rd, Abbotsford, BC, Canada V2S 7M9

US Shipping Address: 88-446 Harrison St, Sumas, WA 98295 US Mailing Address: PO Box 231, Sumas, WA 98295

Phone: 604-853-6096 Fax: 604-853-8749 Internet: www.bd-power.com