



2003-2007 Ford 6.0L E-Series BD Remote Mount Exhaust Brake

Part Number	Application
1027148AP	Ford 6.0L E –Series Powerstroke with 3.5” Exhaust (Auto Trans)

Serial # _____

Date Purchased _____

Purchased from _____

Installed by _____

OWNER’S MANUAL – LEAVE IN GLOVE BOX

Exhaust Brake TABLE OF CONTENTS

Kit Contents 3

Welcome..... 4

Options 4

Installation 5

 Battery Disconnect & Removal 5

 Air Compressor & Reservoir Installation 5

 Valve Installation 6

 Air Solenoid Installation..... 7

 Air Line Wiring..... 8

 Under Hood Wiring..... 9

 Hose Routing & Wiring Schematic 10

 Cab Wiring 11

 Brake Module Wiring Schematic 12

 PCM Wiring 13

 EBP (Exhaust Back Pressure) Sensor Wiring..... 14

 Cruise Control Wiring 17

 Control Wiring 18

 Battery Reinstall 18

 Brake Controller Calibration 18

 Exhaust Brake Testing 19

Maintenance & Troubleshooting..... 20

Common Problems 21

Exhaust Brake Adjustments..... 22

Operating Guidelines 22

Auto/PressureLoc Description 26

Installation 26

AutoLoc Wiring Schematic..... 30

AutoLoc Adjustments 31

Troubleshooting 34

Kit Contents

1027148AP 6.0L E-Series Kit Components

1	1030132	E-Series Air Pump Kit (w/ mounting bracket)
1	1127038	Valve Kit
1	1220048	Air Solenoid Assembly
1	1321045	Application Kit
1	1331047	Control Kit Wiring Harness
1	1220114	E-Series Air Snorkel Kit
1	1220100	Brake Snorkel Kit
2	1100350	3.5" Pipe Adapter
2	1100404	4.0" Marmon clamp
1	1100735	3.5" Lap Exhaust Clamp
1	1031301	Ford E-Series AutoLoc/PressureLoc

BD Engine Brake Inc.

Plant Address: 33541 MacLure Rd. Abbotsford, BC, Canada V2S 7W2

U.S. Shipping Address: 88-446 Harrison St, Sumas, WA 98295 U.S. Mailing Address: P.O. Box 231, Sumas, WA 98295

Phone: 604-853-6096 | Fax: 604-853-8749 | Internet: www.bd-power.com

Welcome

Thank you for purchasing a BD Engine Exhaust Brake. Your kit should have the above-mentioned items for your installation; please check to make sure that you have everything. This manual is to aid you with your installation and operation of your braking unit. We strongly suggest that you fill out the installation information and retain this manual for any future reference.

Options

Description	Part #
Transmission Gauge Kit (Auto Trans)	1030584
X Monitor (3 in 1 Digital Gauge)	1087210
Performance Torque Convertor	Call

BD Engine Brake Inc.

Plant Address: 33541 MacLure Rd. Abbotsford, BC, Canada V2S 7W2

U.S. Shipping Address: 88-446 Harrison St, Sumas, WA 98295 U.S. Mailing Address: P.O. Box 231, Sumas, WA 98295

Phone: 604-853-6096 | Fax: 604-853-8749 | Internet: www.bd-power.com

Installation

Battery Disconnect & Removal

Disconnect the negative terminals on both of the vehicle's batteries, and then disconnect the positive terminals. The passenger side battery will have to be temporarily removed for the installation of some of the components of this kit.

Air Compressor & Reservoir Installation

Install the supplied air compressor/regulator kit on the outside of the passenger side frame rail, just to the rear of the passenger door. You can use some of the pre-existing holes in the frame but you will need to drill at least two 3/8" holes in the frame, and maybe more depending on the truck's configuration. You can use the air compressor assembly as a stencil to outline the drill pattern. Use the supplied mounting hardware to secure the assembly to the frame rail.

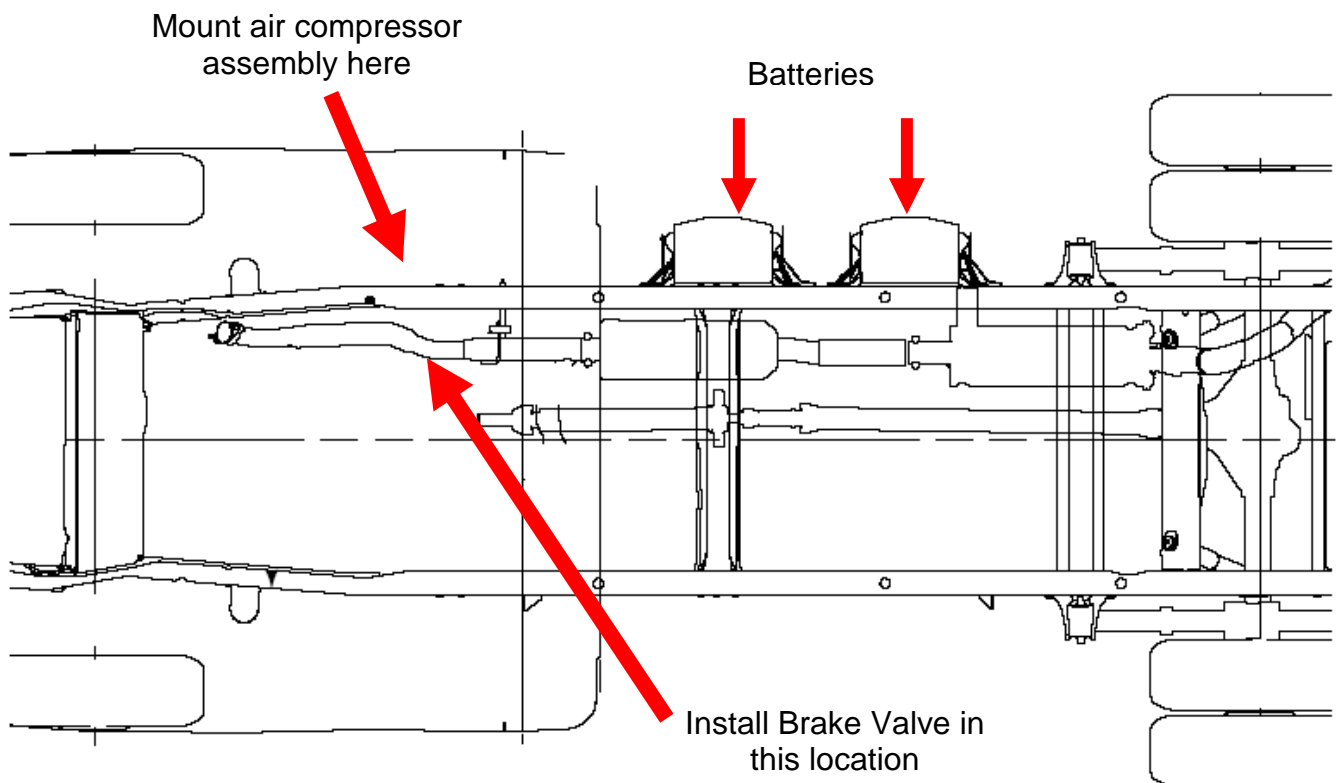

You will need to route battery power to the air compressor assembly and you may use the frame rail as a ground. Ensure that the frame is clean and there is no undercoating isolating the ground point. See the wiring diagram for further details.

Valve Installation

If possible, locate an 8" straight section of pipe before the catalytic converter. If this cannot be found, you can locate an 8" section after the catalytic converter. It is beneficial to have the brake valve installed before the catalytic converter due to the elimination of possible exhaust leaks. The rear clamp on the catalytic converter has been known to leak.

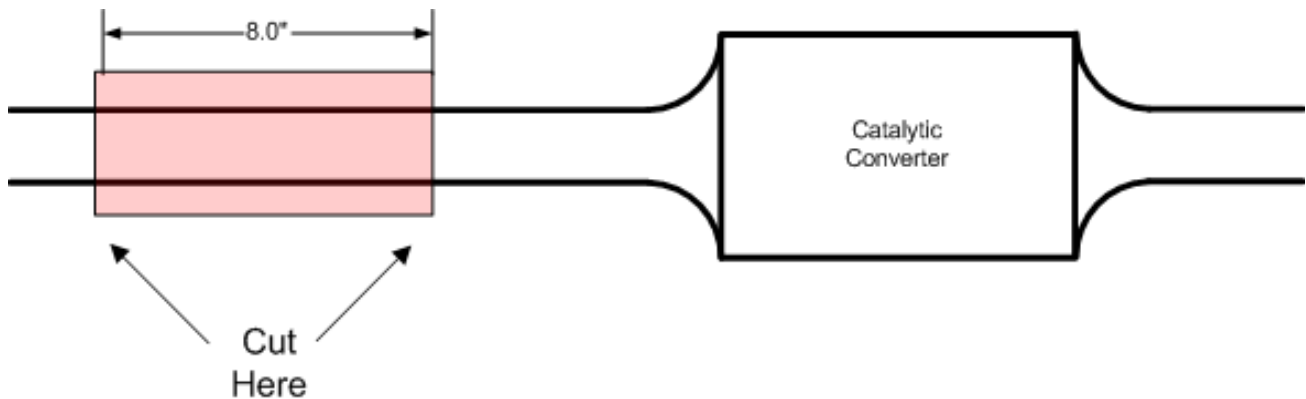

Slide the supplied flanges over the each side of the cut exhaust. The flange closest to the front of the vehicle will need to be welded. A good clean weld is needed to seal the high backpressure that the exhaust brake will create. The rear flange should be mounted with the supplied stainless band clamp.

Insert the valve assembly in between the two flanges and ensure that there is ample room when welding and tightening the two flanges. Also take note that there is an exhaust flow direction arrow cast into the exhaust brake. This arrow should be pointing **towards the rear of the vehicle**. Once you have finalized the fit by welding the front flange and securing the rear the flange, tighten the two supplied V clamps around both flanges on either side of the exhaust brake. The exhaust brake should now be held securely in place.

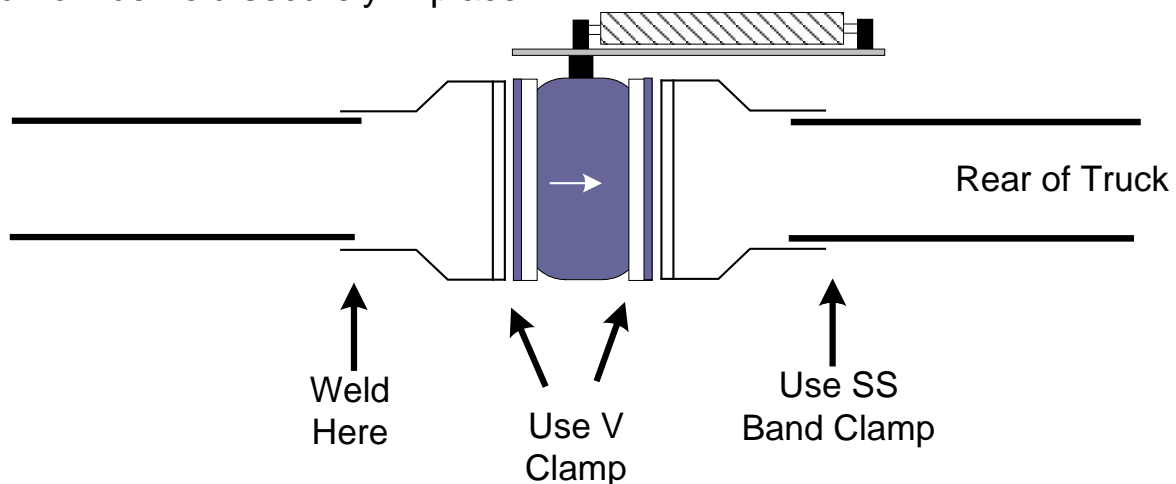

Air Solenoid Installation

Just across from the exhaust brake on the passenger side frame rail you will notice a number of factory holes in the frame. You will need to mount the air solenoid assembly on the inside of the frame rail utilizing one of these holes. Make sure that the air solenoid assembly is as close as possible to the exhaust brake to ensure a quick engagement and disengagement of the valve.

At the same time it is a good idea to install the feedback diode harness. Connect the connectors together matching Black to Black (Ground) and Red to power. Connect the ground eyelet to the mounting bolt attached to the frame. The other bullet connection will be connected to the brake activation circuit.



Consult the wiring diagram for proper connections.

Air Line Wiring

Starting first at the outlet of the pressure regulator, use the supplied ¼" nylon air tubing to connect the regulator to the brass solenoid valve that is installed on the frame rail. To install the air line, just insert and push to lock the line in place. To remove depress the collar and pull the air line out.

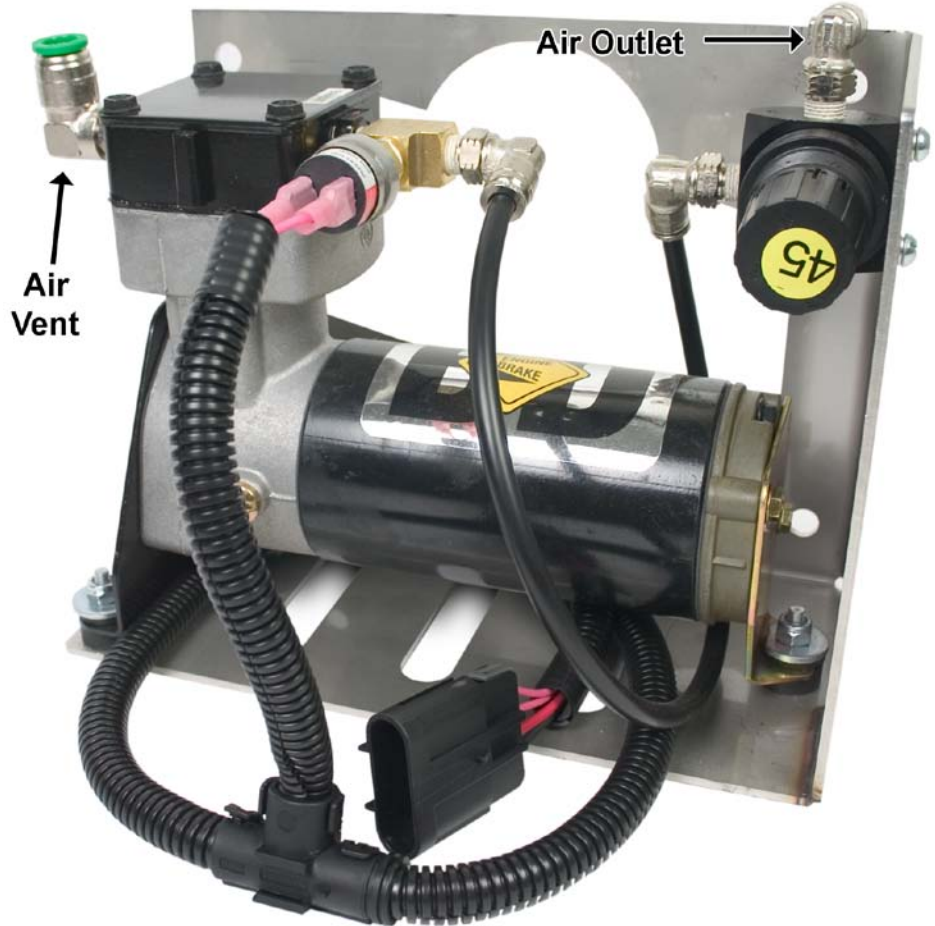

From the brass solenoid valve you should then route the ¼" nylon air line to the valve assembly. Insert the air line into the quick release valve, which is connection to the aluminum valve cylinder.

Connect the air line into the snorkel outlet of the valve cylinder. Be careful as this connector can be fragile. You will need to route the air line to the under hood compartment where it will be free from moisture. There should be a yellow snorkel filter connect to the end in the engine compartment.

Back at the air compressor assembly, you will need to connect the large 3/8" nylon air hose to the vent of the air compressor. This air hose should also be routed into the under hood compartment in a cool dry location. Refer to the wiring diagram for clarification.



BD Engine Brake Inc.

Plant Address: 33541 MacLure Rd. Abbotsford, BC, Canada V2S 7W2

U.S. Shipping Address: 88-446 Harrison St, Sumas, WA 98295 U.S. Mailing Address: P.O. Box 231, Sumas, WA 98295

Phone: 604-853-6096 | Fax: 604-853-8749 | Internet: www.bd-power.com

Under Hood Wiring

Start by locating a dry, cool and secure location for the relay. Keep in mind the wire lengths as you will need to connect to the pressure switch on the air compressor assembly. As well you will need to provide power to the relay from the battery which is located on the frame rail.

Once the relay has been secured, route power to pin 30 of the relay from the battery. From pin 87 of the relay you should connect this to the red wire that powers the air compressor. The black ground wire from the air compressor should be connected to a clean ground point on the frame rail.

Now connect the two female blade connectors from the wiring harness to the pressure switch, note that it does not matter which connector goes where.

You will also need to locate another ground point for the wiring harness to be grounded. This ground location can be the same as the air compressor ground point.

Note: You do not need to connect the spare male bullet connector. It should be taped off.

Finally you can now route the solenoid control wiring towards the brass solenoid valve you installed earlier. There has been an extra length of black wire provided to reach the solenoid valve. You can connect the wires together; ensure that the feedback diode has been installed inline as well.

The brake control wire can be routed to wards the under hood compartment. This connection will connect to the brake controller mounted in the cab.

Hose Routing & Wiring Schematic

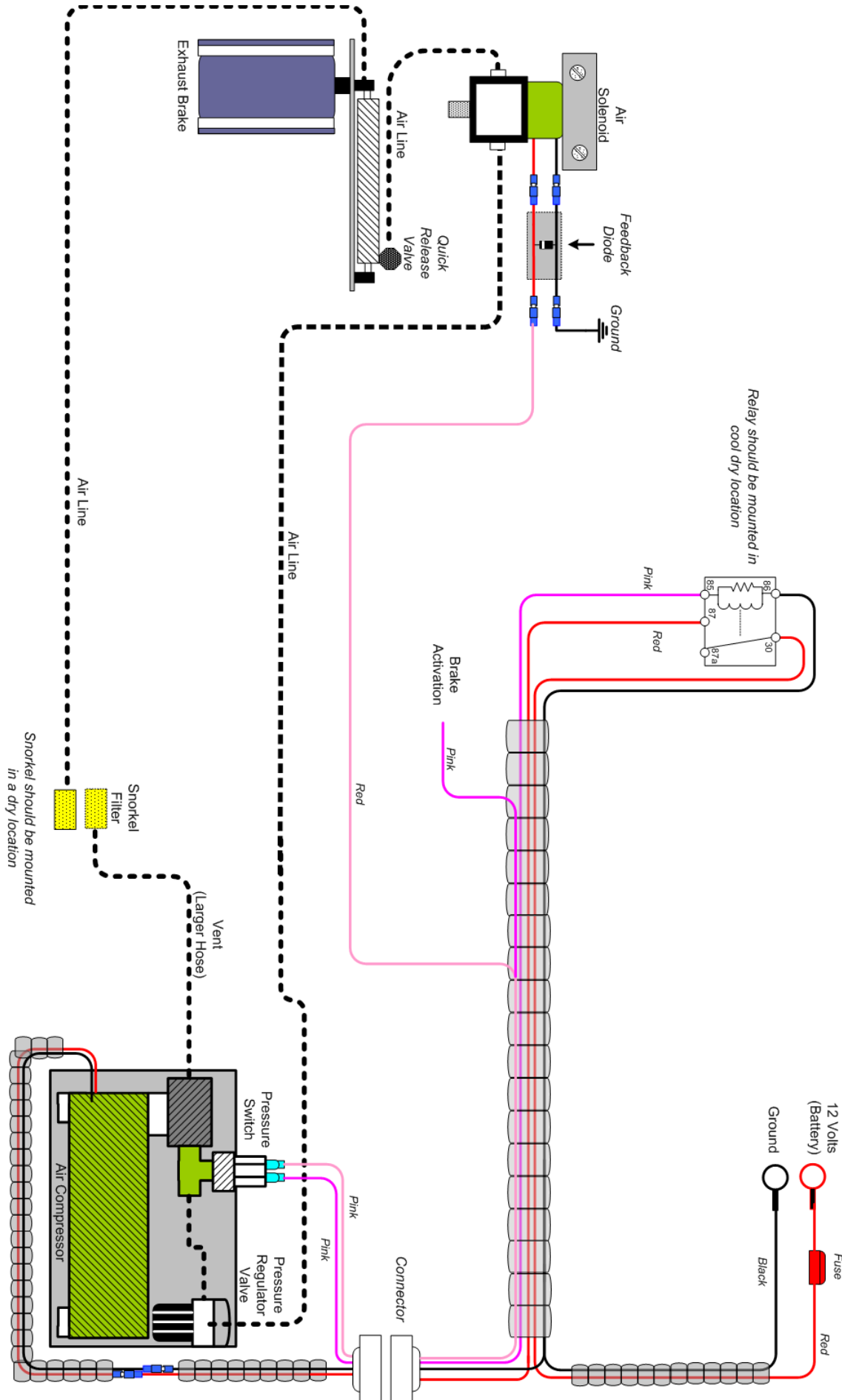

BD Engine Brake Inc.

Plant Address: 33541 MacLure Rd. Abbotsford, BC, Canada V2S 7W2

U.S. Shipping Address: 88-446 Harrison St, Sumas, WA 98295 U.S. Mailing Address: P.O. Box 231, Sumas, WA 98295

Phone: 604-853-6096 | Fax: 604-853-8749 | Internet: www.bd-power.com

Cab Wiring

Remove the lower section of dash, under the steering column, and mount the 6.0L Brake Control module to the cross member. Connect the black wire from the 6.0L Brake Control module to a good clean ground using the round eyelet. You will also use this ground point for the on/off switch (black wire).

Locate one of the ignition switched Red /Black tracer wires under the steering column (one is 10/12ga and the other is 14/16ga) and connect an appropriate Posi-Tap connector to it (green for 10/12ga and black for the 14/16ga wire). Also note that fuse #29 in the central junction box underneath the dash will also work.

Connect the red wire from the 12V (Switched power) input of the brake controller to this Posi-Tap. You should also use this connection to power the on/off switch (red wire).

When wiring the on/off switch, be sure to leave yourself enough wire length when mounting the switch in the dash. You will need to drill a ½" hole in the dash to accommodate the toggle switch. Connect the ground (black) and power (red) wires to the switch using the supplied female blade connectors. The ground wire must be connected to the terminal labeled "AMBER". The provided tan wire should go to the TOGGLE SWITCH terminal on the brake controller and be connected to the output of the switch.

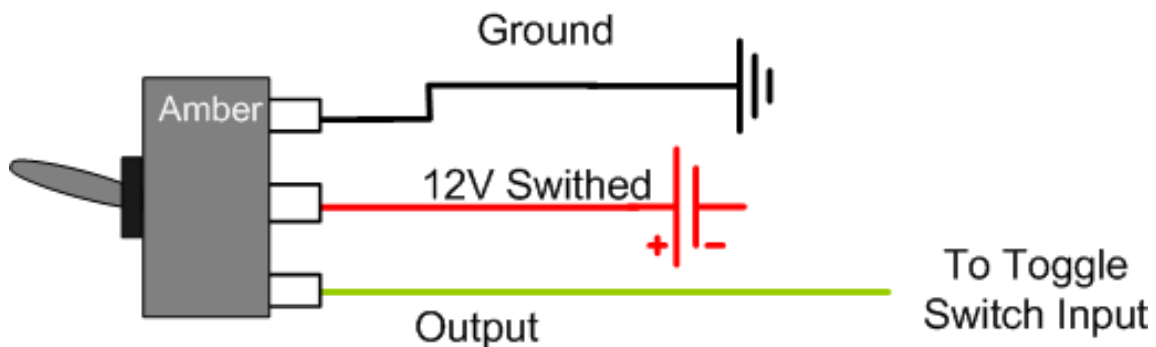

Locate the Throttle Position Sensor at the throttle pedal and, using a Posi-Tap connector, attach the **Yellow** wire from the brake controller module to the correct APPS/TPS wire. If this wire does not exist, you will need to locate a wire that varies its voltage according to how much the throttle is depressed (0.5V to 4.5V). This wire should be connected to the APPS/TPS terminal of the brake controller.

Vehicle Year	APPS/TPS Wire Color
2003-2007	White w/Red

Brake Module Wiring Schematic

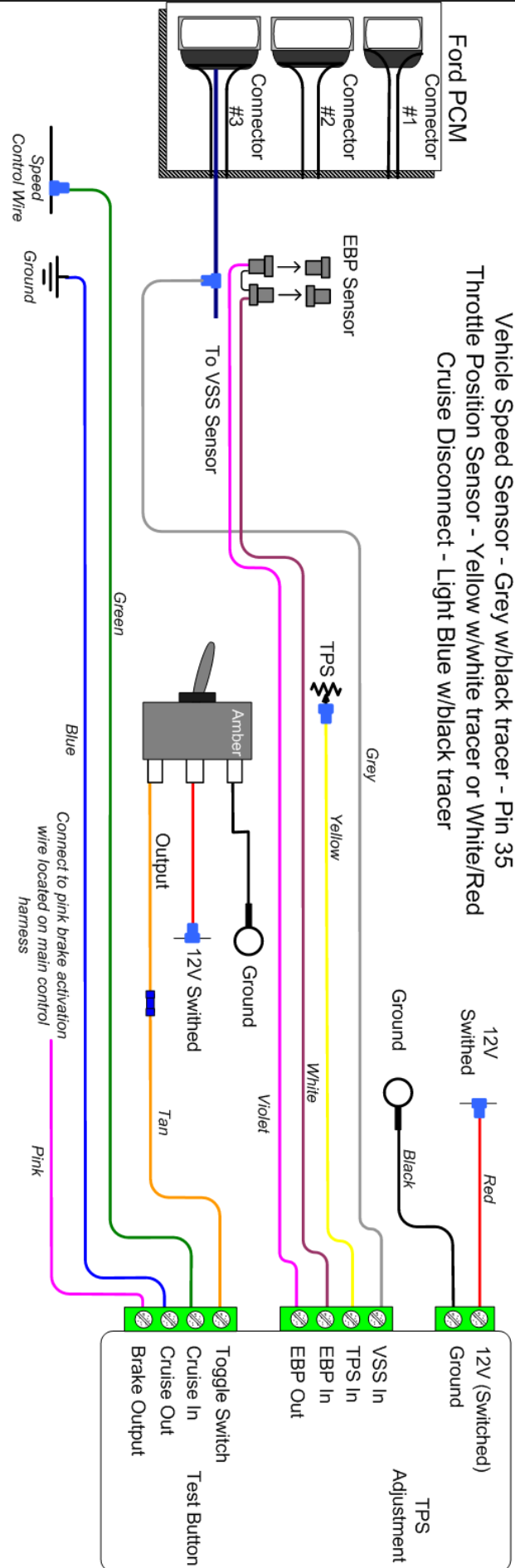

BD Engine Brake Inc.

Plant Address: 33541 MacLure Rd. Abbotsford, BC, Canada V2S 7W2

U.S. Shipping Address: 88-446 Harrison St, Sumas, WA 98295 U.S. Mailing Address: P.O. Box 231, Sumas, WA 98295

Phone: 604-853-6096 | Fax: 604-853-8749 | Internet: www.bd-power.com

PCM Wiring

You will now need to connect one wire to the vehicle's PCM. Push the white, grey and purple wires through the firewall from the underneath the hood. Run the pink wire through the firewall as well (this will be used later on). Connect the grey wire to the VSS terminal, the white wire into the EBP INPUT terminal and the purple wire to the EBP OUTPUT terminal of the brake controller.

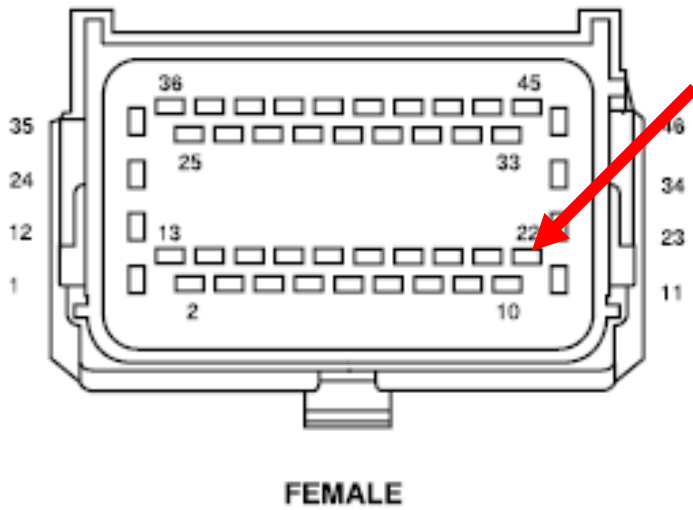

Wire Color	Pin
VSS Wire	Grey w/Black
	22

Remove the locking plugs from the ECM for easier access.

Use the supplied Posi-Tap to connect the grey wire to the Vehicle Speed Sensor (VSS) wire. This wire is grey w/black tracer and is located

on **connector A, pin 22**. This wire should be connected to the VSS terminal on the brake controller.

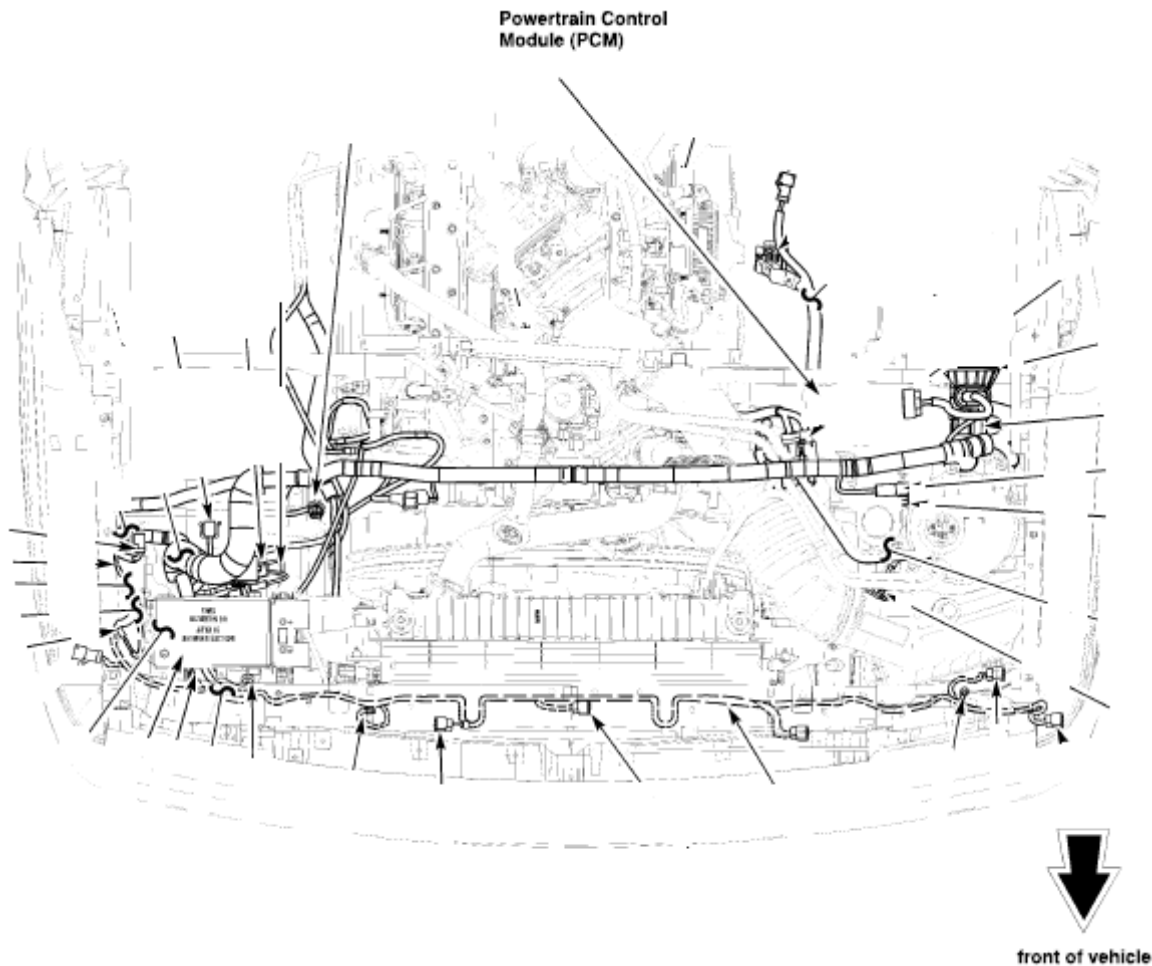

EBP (Exhaust Back Pressure) Sensor Wiring

Locate the exhaust back pressure sensor (**EBP**) at the front of the engine on the driver side. Disconnect the factory plugs from the EBP sensor.

There will be a white guide tab that will either be attached to the end of the factory connector (as shown to the right), or it will be inside the connector portion of the EBP Sensor.

This guide will have to be removed as it will need to be installed into the exhaust brakes' EBP harness.

Once you have removed the guide, insert it into the exhaust brake's EBP harness into the **MALE CONNECTOR**, as shown in the picture to the right.

Reconnect the factory plug into the provided female plug. When installing the plugs, be sure that no pins get pressed out the backside when inserting the plugs together.

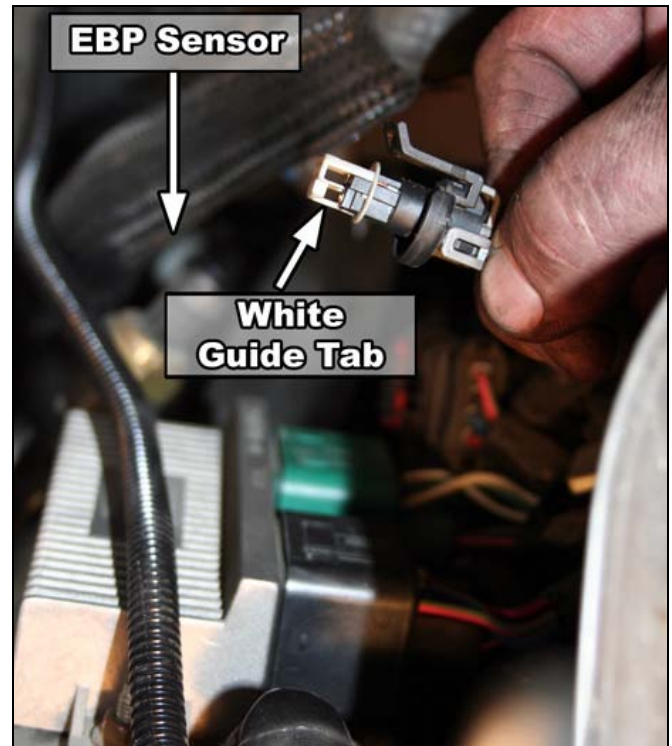



The supplied **violet** wire should be connected to the **EBP OUTPUT** terminal, while the supplied **white** wire should be connected to the **EBP INPUT** terminal of the exhaust brake controller.

Please reference the wiring diagram to remove any discrepancies that you may have.

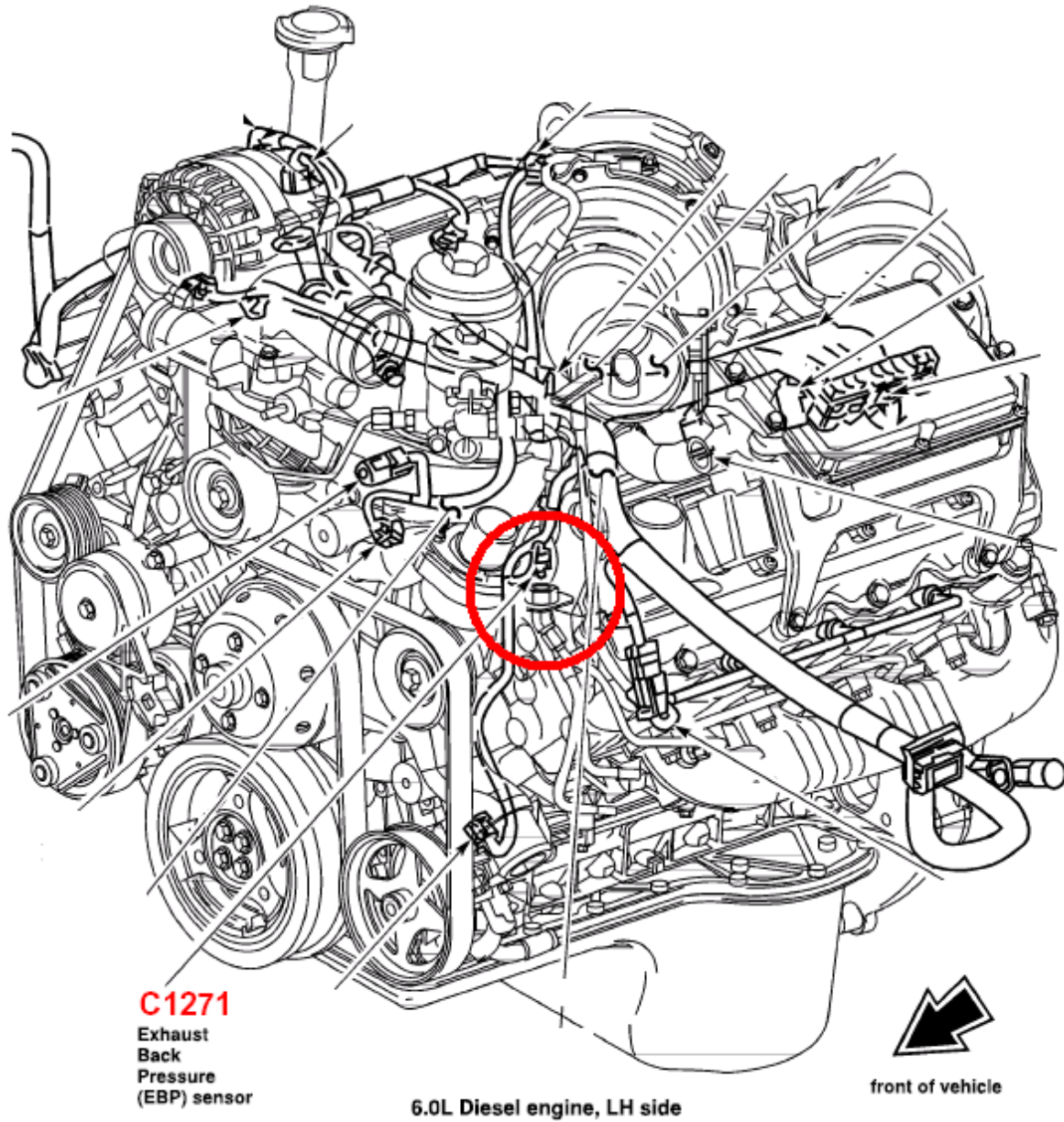

You may now reinstall the PCM connectors and the battery cover.

Cruise Control Wiring

NOTE: If the vehicle does not have Cruise Control, remove the Green and Blue wire from the install and discard.

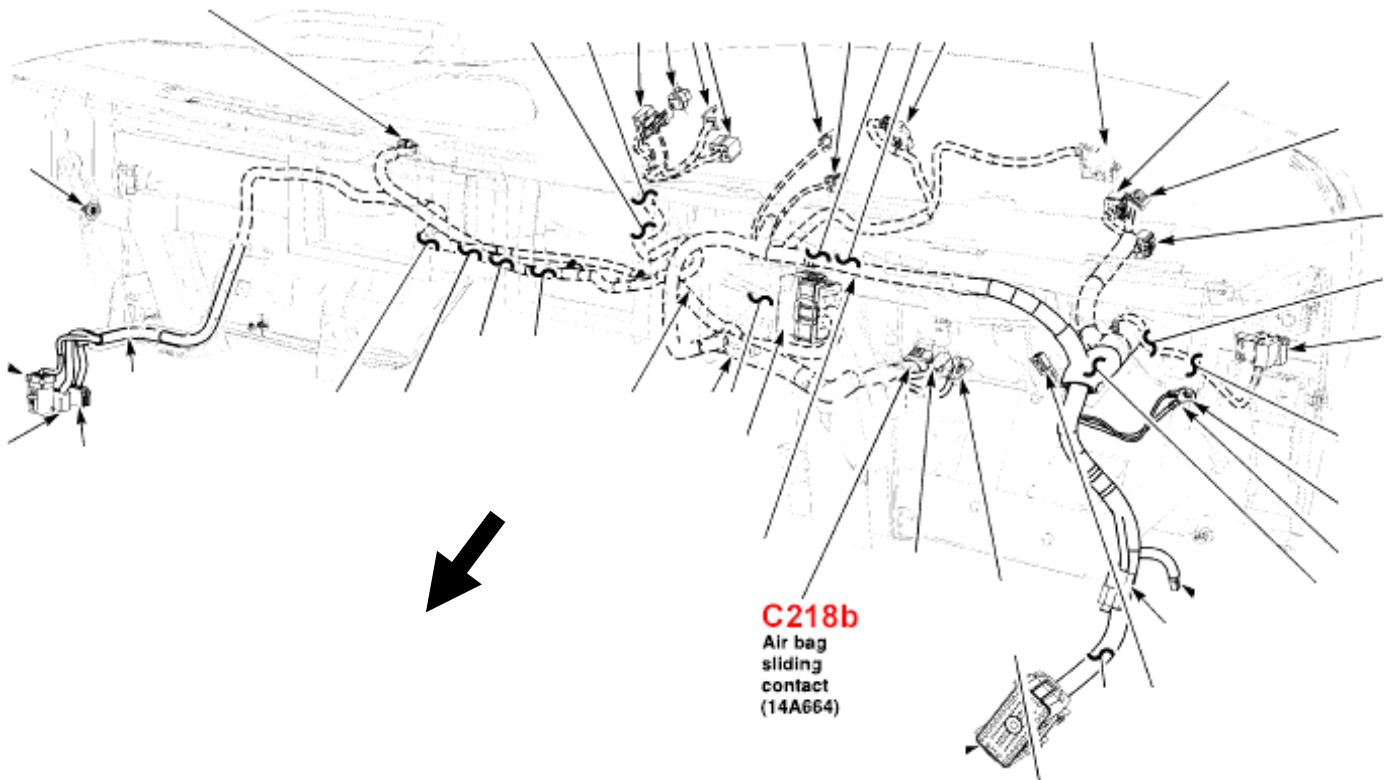

You will now need to locate the 6 pin connector located just underneath the steering column on the passenger's side. In this connector will be the speed control switch input **Light Blue/ Black** wire. Attach the supplied red T-tap connector to this wire. This green wire should then be wired into the "CRUISE IN" input of the brake controller. The supplied blue wire should then be wired to ground and then into the "CRUISE OUT".

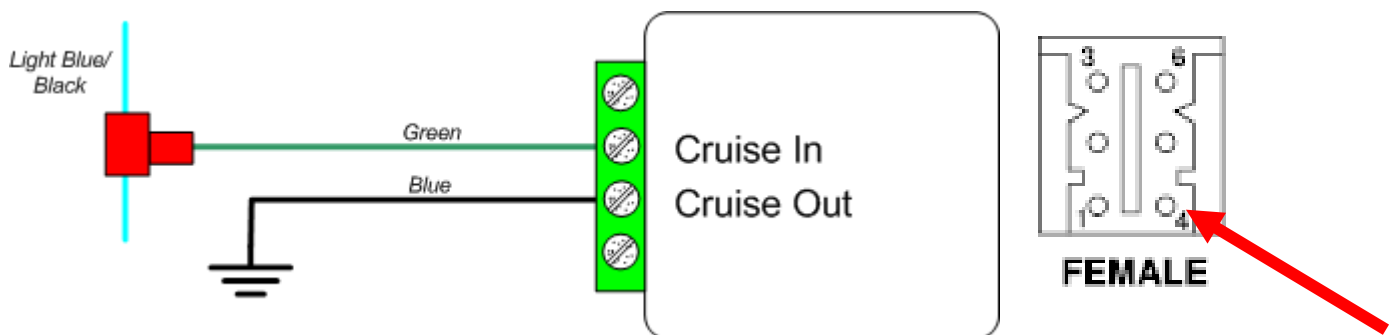

Cruise Wire	Wire Color	Pin
2004-05	Light Blue w/Black	4
2006	Light Blue w/Black	6

Control Wiring

Connect the **pink** brake activation wire that was brought through the firewall to the **BRAKE OUTPUT** of the brake controller. This wire should be routed along the top of the firewall, under the hood. You must keep this wire away from the turbocharger, as exposed heat will melt this wire. You will need to connect a female bullet connector to the end of the pink wire, which then should be connected to the Brake Control relay.

Battery Reinstall

Re-install the passenger side battery. Reconnect the positive terminals on both batteries then reconnect the negative terminals.

Brake Controller Calibration

Ensure the connections of the corresponding wires to the Brake Controller Module are correct as shown in the wiring diagram.

To achieve the correct setting for the activation of the exhaust brake in relation to the throttle pedal the Brake Controller Module must be calibrated for your vehicle.

The Brake Controller has an LED inside of the case that should be visible through the case indicating brake activation.

With the throttle at idle, start the engine and turn on the brake switch. Using a small flat bladed screwdriver, turn the small adjusting screw (potentiometer) on the right side of the Brake Control Module counterclockwise or clockwise until the brake engages and the LED JUST turns on.

Hold the small test button on the side of the Brake Controller during this process. This button must be pressed to calibrate the engagement/disengagement point of the exhaust brake, as normally the exhaust brake disengages at 15mph.

CAUTION: THE ADJUSTING SCREW IS A MICRO-SWITCH WHICH IS VERY DELICATE, SO TURN USING SMALL ADJUSTMENTS.

Test by revving up the engine to approximately 1000 RPM and releasing the throttle. As the accelerator pedal is applied, the test light should turn off just before the engine starts to rev, indicating proper calibration of the Brake Controller Module with the TPS. Remember to keep the test button depressed.

The exhaust brake and LED should activate again when the throttle pedal returned to idle. If not, readjust the Brake Control Module so that it does. Reinstall lower dash cover.

Exhaust Brake Testing

Start the vehicle and check for idle pressure.

The idle pressure should be preset at 10–15 lbs from the factory, so it should not need to be adjusted. If an adjustment is thought to be necessary, please go to the exhaust brake adjustment section.

NOTE: The butterfly valve has been preset at the factory and should not be adjusted.

Start the vehicle and take it for a test drive. The brake will only engage above 15 mph - it will not operate below this speed. Take the vehicle above this set speed, turn on the brake activation switch and let off of the throttle. The brake should apply and you should feel the vehicle slow down. Once 15 mph is reached, the brake will disengage automatically. Accelerate past the threshold speed once more, and let off the throttle once again. Re-apply the throttle and make sure the brake **quickly** disengages.

The brake must quickly disengage, if it does not, a PCM error code may be generated. Some common reasons for a slow reacting brake would be from the brake controller not being adjusted correctly, or the air solenoid valve being too far away from the brake.

Next you will need to test the brake for maximum retarding pressure. You can either do this under load from a large hill or perhaps from letting off the throttle at a high RPM.

The regulated pressure is adjusted with the regulator on the control assembly and has been preset to allow a MAXIMUM of 45psi of exhaust back pressure. Note that you should try to attain this maximum pressure.

CAUTION: Do NOT exceed 45 psi of back pressure.

While driving, turn on the cruise control, and then activate the brake. The activation of the brake should disconnect the cruise control. Turn the brake off and activate cruise control again, this time pressing down on the hydraulic brake pedal to ensure that the cruise control disconnects when the brake pedal is applied.

You may also notice that every time the vehicle is started, the exhaust brake is cycled for a 1/10th of second. This should help everything stay free and clear and reduce the possibility of the valve being contaminated.

NOTE: Over the next two weeks, the backpressure at idle may rise due to the initial carbon build up and the brake valve will need to be adjusted again.

Check for any exhaust leaks and re-check all connections and hoses for security and interference from moving or heated items. After about 100 miles (160 km), re-torque the turbo exhaust clamp and flange bolts.

Maintenance & Troubleshooting

Your exhaust brake has been designed so that every time the vehicle is started the exhaust brake will cycle for 1/10th of a second. This will extend the operating life of the brake substantially.

On a twice-yearly interval, check and adjust the brake pressure to 10-15 lbs while the engine is at idle. The hoses, wires, fittings and clamps should be inspected on a regular basis for any deterioration, damage, or leaks.

By following the diagrams in this manual, trace hoses and wiring, check continuity through electric components, and check for any lines that are disconnected.

This should solve any problems that may arise but if you should need any assistance or need replacement parts, call our **Technical Service** department at 1-800-887-5030, between 8:30am and 4:30pm Pacific Time.

Troubleshooting

Version 2

For one whenever the brake controller is powered there will be a flashing light. This shows that the unit has power and the microprocessor is functioning normally. The second LED comes on when the Brake Output is energized. For example when you press the test button.

Version 2.01 and Newer

This unit does away with the blinking light. There will be a Red LED that operates when the Brake Output is energized This shows that the brake is being requested to activate. The green LED will only come on once the VSS signal is met. So below 15 mph the LED will be off above 25 mph the LED will be on.

As well you will notice an "EBP ADJ" potentiometer on the side of the brake controller. The potentiometer is only used if you run into EGR problems. Please contact BD before adjusting this.

Common Problems

Brake cycles ON/OFF upon disengagement speed – To cure this problem, a new ground should be found for the Brake Controller. Electrical noise on the ground and the VSS line cause this symptom.

Brake does not activate – Check all the wire connections and make sure that when the brake is supposed to be energized that 12V exists on the Brake output of the Brake Controller. Whenever the brake is supposed to be energized, a red LED should be lit inside of the brake controller. You can check this operation by pressing the test button on the side of the controller. Check to make sure that the idle verification potentiometer has been adjusted correctly and that the activation switch is in the ON position and is providing 12V to the switch input.

Upon disengagement of brake, Vehicle bogs down – Make sure that the feedback diode wiring assembly is installed at the solenoid valve. Without this, sporadic operations will result.

Exhaust Brake Adjustments

As mentioned in these installation instructions, the backpressure must be measured and adjusted when the vehicle is at idle. There is a 1/8" NPT port on the side of the exhaust brake casting designed for a pressure gauge.

It is required that a standard pressure gauge be used to make the necessary adjustments to the brake valve. Adjust the brake to reach approximately 10-15 lbs while the engine is at idle.

DO NOT SET THE VALVE TO STROKE AGAINST THE VALVE CASTING WALLS AS WARRANTY WILL BE VOIDED.

Operating Guidelines

Thank you for taking interest in the BD Engine Exhaust Brake. As a driver, you probably already know the need for extra braking power that your vehicle requires on the hills and long grades. With loads being towed behind you, the extra push when slowing down or maintaining speed on downward grades can prove to be a great strain on the vehicle hydraulic braking system, even to point of "burn-up".

These guidelines were designed to offer a better understanding of the benefits of using exhaust brakes and are based on material developed by the US Department of Transportation National Highway Traffic Safety Administration.

The emphasis on today's vehicles is to give the consumer a product that can give them usable power with fuel efficiency. But, in the transition, the vehicles have lost their natural braking power, making it more easy for the vehicle to continue to roll and harder to stop. Of course, this gets more noticeable with the increase of weight, on or behind the vehicle. This is where an exhaust brake becomes a useful tool in increasing the driveline drag of the vehicle without the use of the hydraulic brakes.

A tool, with maximum use or even occasional use that can reduce wear on hydraulic braking parts and at the same time increase safety. The BD Exhaust Brake can be used to help maintain a controlled vehicle speed on a downward grade, as well as slowing the vehicle down for such times as turns or exit ramps, without you using your hydraulic brakes.

However, the exhaust brake cannot be used as a parking brake or a service brake to bring your vehicle to a complete stop.

By using a BD Exhaust Brake, the life and effectiveness of your hydraulic brakes will increase. This is because of the decreased use of the hydraulic brakes in situations like hills, the wear factor is reduced and there is less opportunity for your hydraulic brakes to heat up which would reduce the efficiency.

BD Engine Brake Inc.

Plant Address: 33541 MacLure Rd. Abbotsford, BC, Canada V2S 7W2

U.S. Shipping Address: 88-446 Harrison St, Sumas, WA 98295 U.S. Mailing Address: P.O. Box 231, Sumas, WA 98295

Phone: 604-853-6096 | Fax: 604-853-8749 | Internet: www.bd-power.com

When you ride your hydraulic brakes, make hard stops or have poorly adjusted brakes, this creates high temperatures and as your brakes get hotter, the more chance there is for fading or failure. With terrain that is a series of up and down grades, the BD Exhaust Brake will aid in reducing exhaust valve warpage. Because of the power needed to pull your vehicle and load up a hill, this generates a lot of heat.

When you have reached the crest of the hill and are now coasting down the other side, the heated valves are too quickly cooled. With the exhaust brake engaged, the heat loss to the valves will be reduced, which can prevent valve warpage. When the toggle switch is turned to the "On" position, the valve is activated every time the driver takes his foot off of the throttle pedal. When the driver puts pressure back on the throttle pedal, the relay is activated and the valve opens again.

Exhaust brakes are designed to operate with the throttle at idle, not to be used in conjunction with cruise controls, and not designed to aid in gear shifting. Such cases could cause damage to engine and/or the exhaust brake. Vehicles may require downshifting to obtain the necessary retarding force.

Automatic transmissions with lock-up clutches in the converters can achieve the best retarding force with the use of a clutch control device (i.e. AutoLoc).

Incorporated with the BD Exhaust Brake, there is a pressure regulating system that will control the created backpressure. If the backpressure reaches the set limit, the exhaust valve will open slightly to relieve the excess pressure.

The brake pressure at idle is required to be checked and adjusted at time of installed, two weeks after installed, and on a regular twice a year interval.

Using a standard pressure gauge and the pressure port on the exhaust valve, the brake pressure at idle must be set between 10 and 15 psi. The best scenario for exhaust braking is when going down hill, select a gear that lets you maintain a constant speed with little or no use of the hydraulic brakes, or, the same gear that would be used to go up the same grade of hill. This also depends on the weight, load or road conditions that the vehicle will come upon.

Therefore, in summary, by using the BD Exhaust Brake, you reduce the need for use of your hydraulic brakes in situations where you need to slow down or maintain (i.e. hills, off ramps, corners, approaching speed changes or traffic lights). By reducing the use of your hydraulic brakes in these situations, this reduces the heat build up, as well as wear and damage to linings and drums. And, when you reduce these factors, you save your hydraulic brakes for when you really need them (i.e. for stopping or emergencies).

The BD Exhaust Brake is not a substitute for your hydraulic brakes and, cannot correct or compensate for poorly maintained or misadjusted brakes. But, when you need to slow down or maintain a constant speed, the BD Exhaust Brake will be a valuable and effective tool. Exhaust Brakes are more efficient at preventing than correcting an over-speed condition.

You may also notice that every time the vehicle is started the exhaust brake is cycled for a 1/10th of second. This should help everything stay free and clear and reduce the possibility of the valve being contaminated.

Thank you and happy motoring,
BD Engine Brake, Inc.



BD Auto/PressureLoc

Ford E-Series 2003-2007

I n s t a l l a t i o n I n s t r u c t i o n s

Part# 1031301

PLEASE READ ALL INSTRUCTIONS BEFORE INSTALLATION.

Cautionary Note:

Please read the disclaimer before proceeding to install this unit.

Installation Manual P/N# I1031301
Printed in Canada

Auto/PressureLoc Description

The new 6.0L AutoLoc is a revolutionary new product from BD Engine Brake. Not only does it have the ability to control torque converter clutch lockup while decelerating, but it also has the ability to increase main line pressure in the *Torq-Shift* transmission. All these functions complement the use of the BD Exhaust Brake and your Ford truck.

For this installation, you will need a transmission pressure gauge capable of displaying up to 300psi.

Installation

1. Disconnect both battery cables on both batteries (ground first). The batteries are located on the passenger side of the vehicle down by the frame rail.
2. You will need to disconnect the air intake hoses to gain access the vehicles PCM located in the middle of the engine compartment just to the right of the engine.

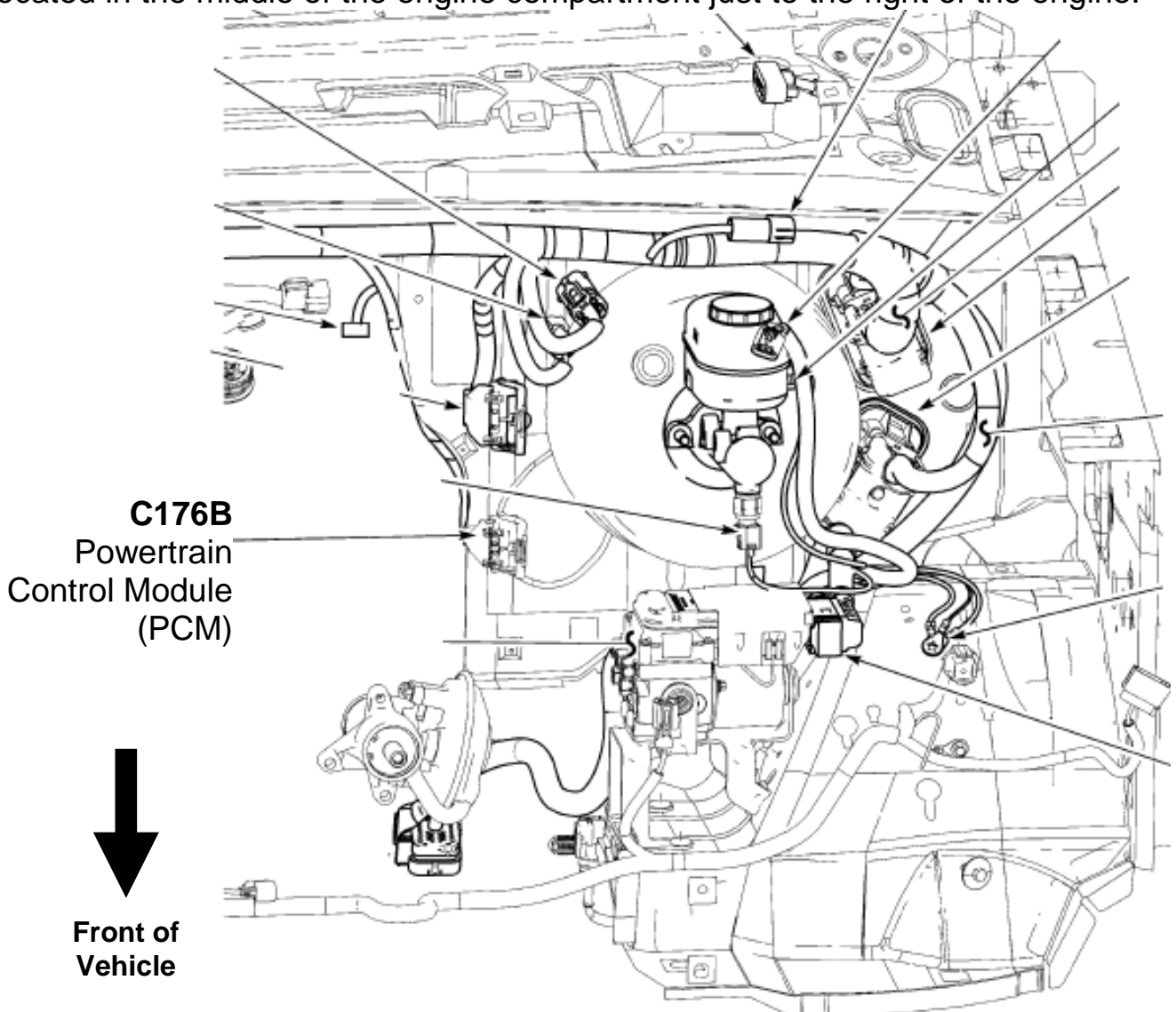

BD Engine Brake Inc.

Plant Address: 33541 MacLure Rd. Abbotsford, BC, Canada V2S 7W2

U.S. Shipping Address: 88-446 Harrison St, Sumas, WA 98295 U.S. Mailing Address: P.O. Box 231, Sumas, WA 98295

Phone: 604-853-6096 | Fax: 604-853-8749 | Internet: www.bd-power.com

3. Disconnect both the lowest connector c176b (30 pin) and the middle c176c connector (46 pin) of the PCM. It is suggested that you work them free to allow yourself some room to access them better.
4. On the lower connector 176b (30-pin connector block) locate the **PCS pressure control** solenoid wire (see table and diagram). You will need to cut this wire and attach a blue Posi-Lock connector.
5. Still on the lower (176b, 30-pin connector block) connector, locate the **TCC control wire** (see table and diagram). Also cut this wire and attach a blue Posi-Lock.

C176B	Ford PCM Pin	Wire Color
PCS	2	Violet/Yellow
TCC	14	Brown/Orange

6. You will now need to connect PCS wires to the AutoLoc wiring harness. The cut **PCS** wire on the PCM side should be connected to **tan** wire in the AutoLoc harness. This tan wire will be connected to pin 5 of the AutoLoc at the factory. These connections should be made using the supplied blue Posi-Lock connectors. See diagram near end of instructions for more information.

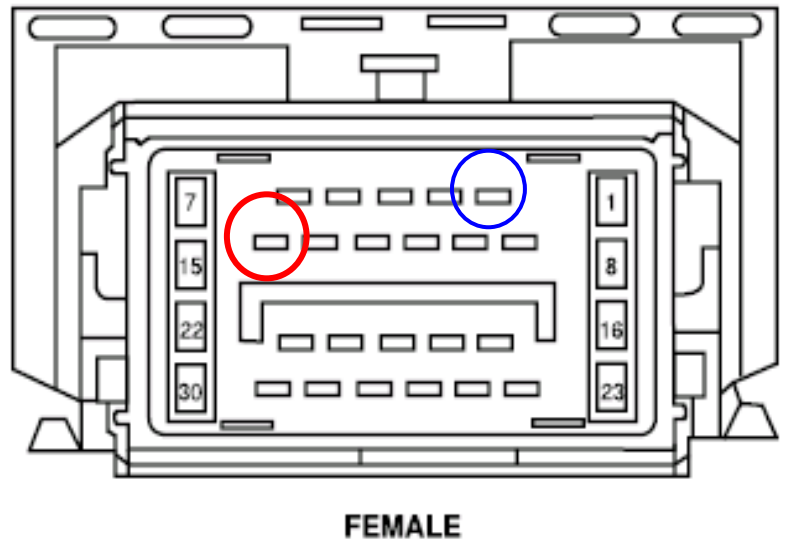

7. The other side of the cut **PCS** wire (should travel to the transmission) should then be connected to the **blue** wire of the AutoLoc harness. This blue wire will be connected to pin 8 of the AutoLoc at the factory. See diagram for more information.
8. Now you can connect the cut TCC wires to the AutoLoc. The cut **TCC** wire closest to the PCM should be connected using the supplied blue Posi-Lock connector to **green** wire of the AutoLoc. This green wire will be connected to the AutoLoc connector at the factory to pin 6. See diagram for more information.

9. Finally connect other side of the TCC wire (should travel to transmission) to the violet wire of the AutoLoc harness. This **violet** wire will be connected to pin 7 of the AutoLoc at the harness. See diagram for more information.
10. You can now reconnect the first factory PCM plug to the Ford PCM.

11. On the middle PCM plug (C176c, 46-pin connector block) you will need to locate the crankshaft sensor output wire.

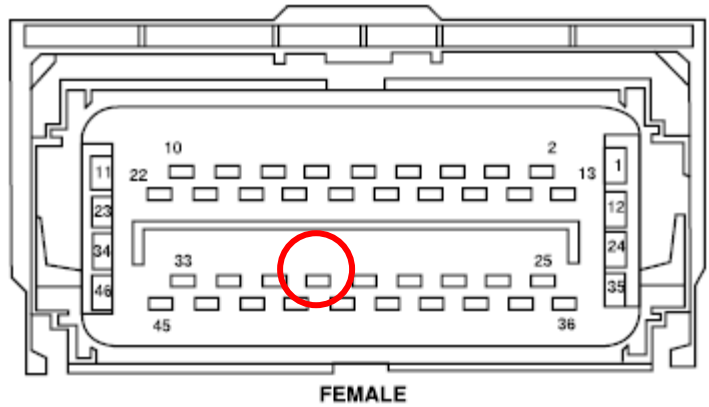

C176C	Ford PCM Pin	Wire Color
Crankshaft Sensor	30	Dark Blue

12. Install the supplied gray Posi-Tap connector to the crankshaft sensor wire. You will need to connect the pink wire of the AutoLoc harness to this Posi-Tap. The pink wire should be connected to pin #3 of the AutoLoc.
13. You can now reconnect the all the PCM connectors to the Ford PCM.
14. You will now need to connect the yellow wire from the AutoLoc harness to the brake activation circuit. This circuit is what activates the exhaust brake on and off. (12V – 0V) You can locate this from the output of the 6.0L Exhaust brake controller as it travels across the firewall over to the passenger side of the vehicle. This wire should be also yellow in color. Apply the supplied Posi-Tap connector to connect the two wires together. This wire should be connected to pin # 10 of the AutoLoc.
15. You can now connect the black ground O-Ring connection to a ground not on the firewall of the engine compartment.
16. You will now need to connect the red power wire to a 12 volt switched power source. You can locate this power source in the fuse panel directly under the steering wheel. You will need to route this red power wire through the firewall into cab to the fuse box. From there locate fuse number F2.29 (10A); the left side is the fused side. Use the supplied fuse tapper and female blade connector to make this connection.

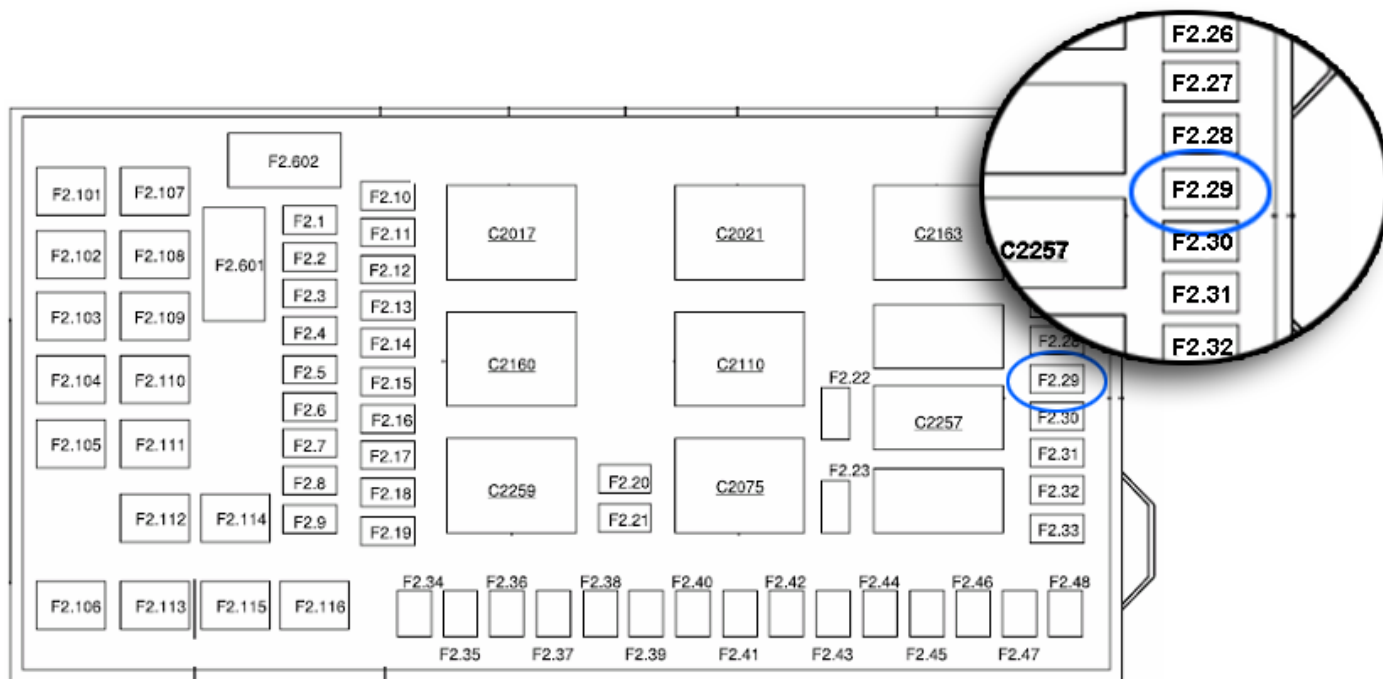

17. Finally you can connect the AutoLoc wiring harness to the AutoLoc unit and install it in the driver's side front corner away from any heat. Zip ties and Velcro have been included in the kit to mount the unit.
18. You may now reconnect all the battery connections and prepare for a test drive.

AutoLoc Wiring Schematic

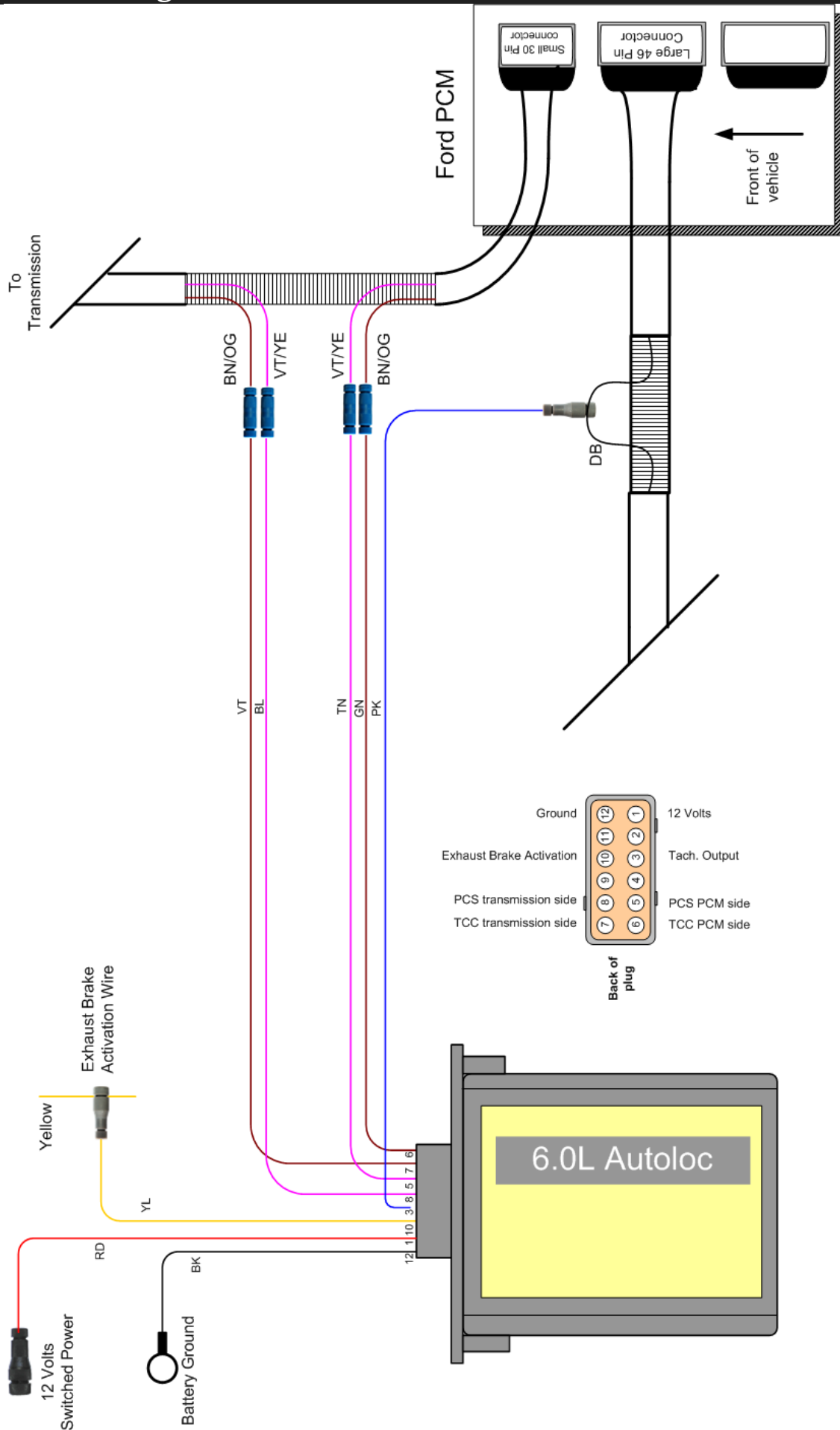

BD Engine Brake Inc.

Plant Address: 33541 MacLure Rd. Abbotsford, BC, Canada V2S 7W2

U.S. Shipping Address: 88-446 Harrison St, Sumas, WA 98295 U.S. Mailing Address: P.O. Box 231, Sumas, WA 98295

Phone: 604-853-6096 | Fax: 604-853-8749 | Internet: www.bd-power.com

AutoLoc Adjustments

You will need to recheck the default settings in the AutoLoc unit before driving. To do this you will need to use a flat screwdriver to unlock the unit from the locking tabs. There are two locking tabs located on the side of the enclosure.

Once the unit is open you will notice the three potentiometers on the right hand side of the AutoLoc board. Disregard the VSS labeled potentiometer. Note the default potentiometer settings, as they may need to be adjusted slightly.

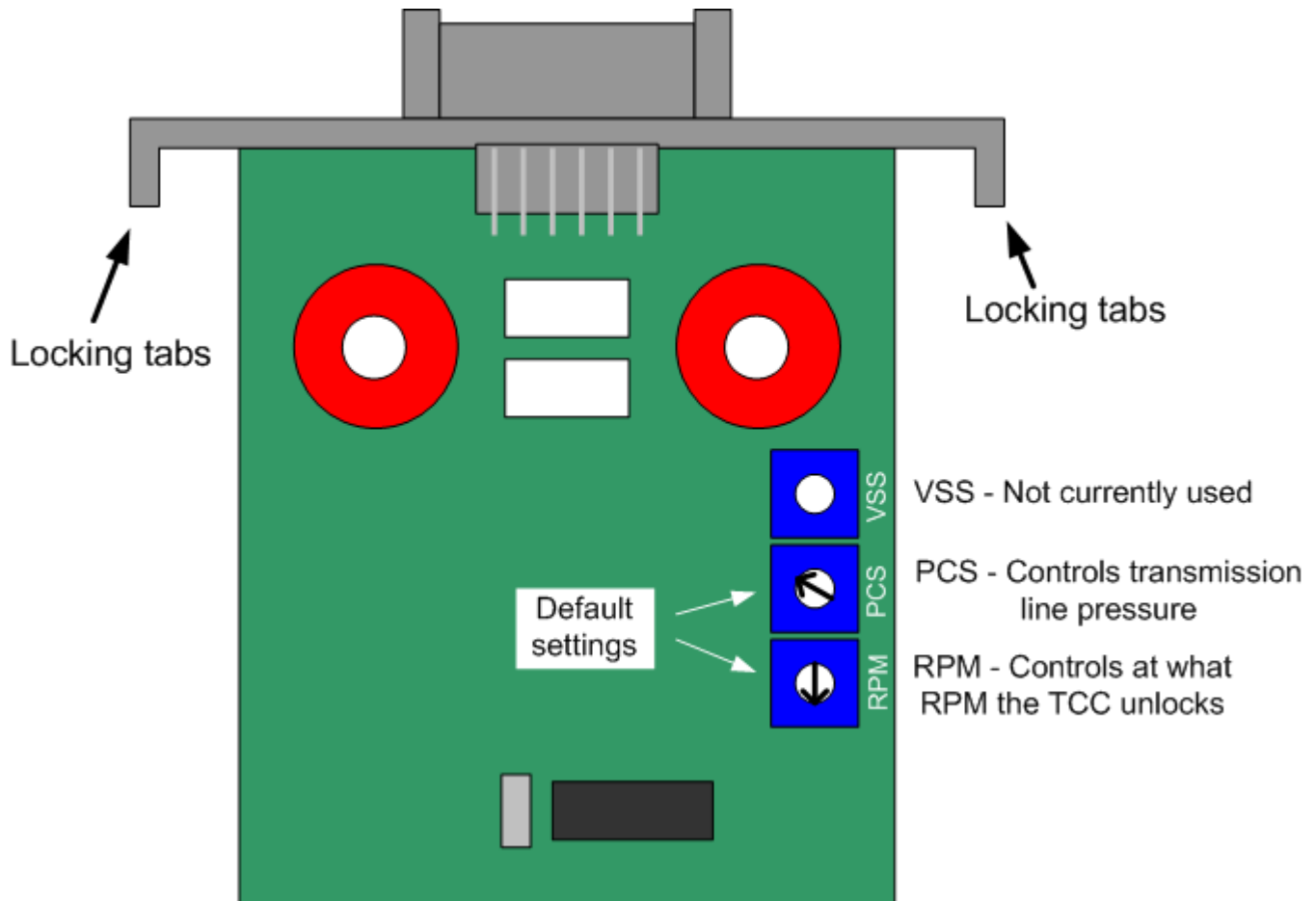

BD Engine Brake Inc.

Plant Address: 33541 MacLure Rd. Abbotsford, BC, Canada V2S 7W2

U.S. Shipping Address: 88-446 Harrison St, Sumas, WA 98295 U.S. Mailing Address: P.O. Box 231, Sumas, WA 98295

Phone: 604-853-6096 | Fax: 604-853-8749 | Internet: www.bd-power.com

19. Starting with **version 2** AutoLoc modules, there is a jumper on the circuit board (see picture to the right). This setting is to tell the AutoLoc module whether an E-Series or an F-Series vehicle is being used, and will adjust the programming settings accordingly.

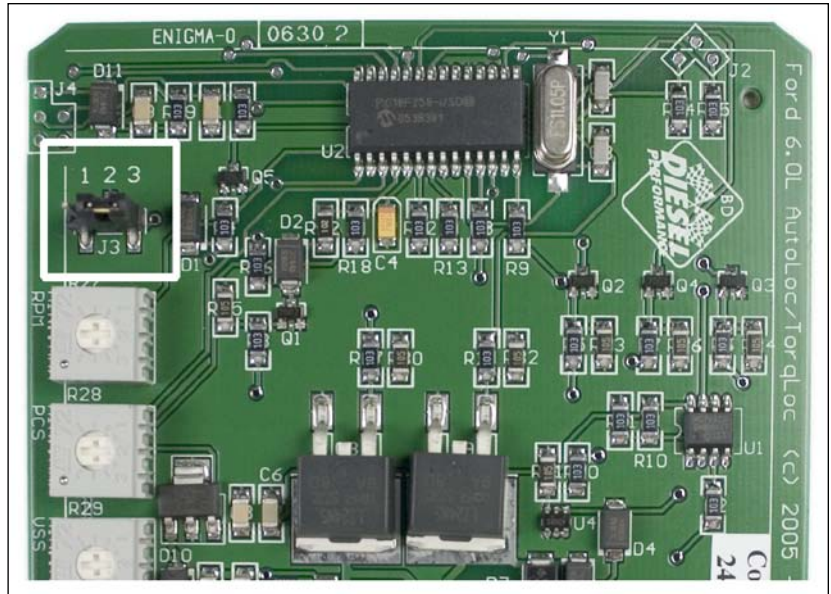

The settings are as follows:

F-Series	Jumpers 1 -2
E-Series	Jumpers 2 -3

You may want to double-check that the jumper settings are correct for your application while you have your enclosure off.

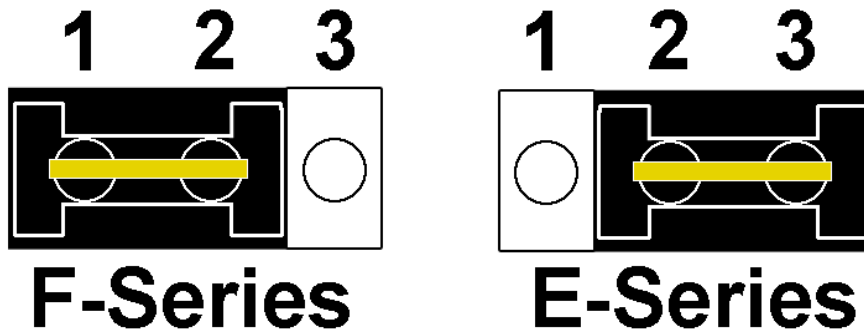

20. Once the default settings are correctly adjusted you can slide the AutoLoc enclosure back together.
21. Before going on a test drive you will need to connect a transmission oil pressure gauge to the transmission to ensure proper operating pressures. The pressure port is located on the driver's side of the vehicle.

On some E-Series vehicles, the pressure port is not accessible. In this case, make sure that the PCS setting is no lower than the default.

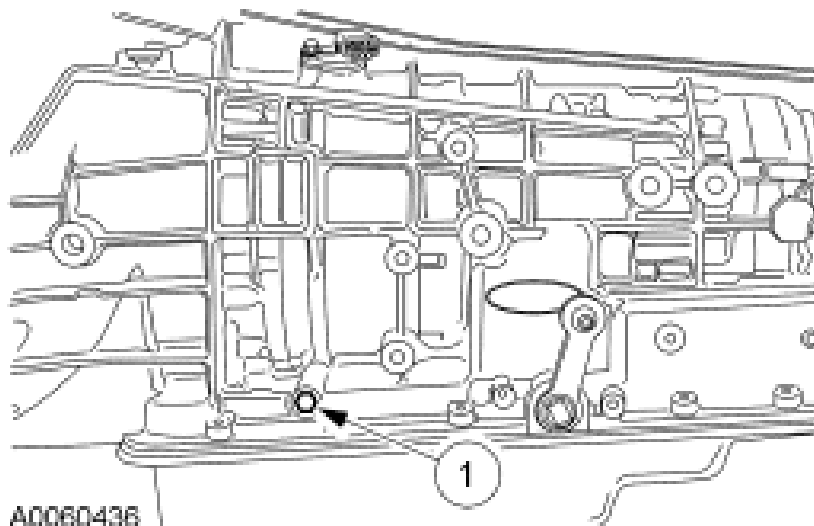

Once the pressure gauge is installed, take the vehicle for a test drive. With the exhaust brake on, drive until the torque converter clutch is commanded ON by the truck then let off of the accelerator pedal. The torque converter should still be engage while the exhaust brake is on.

The desired settings of the AutoLoc are for lockup to disengage at 1250 RPM and the transmission pressure while decelerating in lockup should be 170 psi. If these settings have not been reached, you can re-open the AutoLoc enclosure and adjust the potentiometers. Turn clock wise for more pressure or higher RPM.

Please note that the 170 psi is roughly 10% over stock pressures on our test vehicles. If your vehicle’s stock pressures are at 170 psi to begin with, please increase these pressures 10%.

Lockup pressure while decelerating with the exhaust brake on	180 psi / +10%
Lockup disengagement	1250 RPM

Continue the test drive and adjustments until everything is functioning correctly. Remember the AutoLoc functions only when the exhaust brake is on.

Once everything is operating correctly you can remove the transmission gauge and re-install the battery cover.

Troubleshooting

Problem	Symptom	Resolution
Vehicle starts in limp mode	High idle or harsh engagement	Double check wiring, and ensure connectors crimped properly. Use a voltmeter to check for voltages.
Unusual operation	Odd shifting or error code	Check wiring and/or potentiometer settings.
Harsh down shift	Harsh 1 st or 2 nd gear down shift	Increase the RPM cutout speed.
Soft/Hard Torque Converter Clutch engagement	Soft/Hard clutch engagement	Adjust the line pressure using the PCS potentiometer.
Does not activate	Does not hold lockup or increase line pressure	<p>Make sure exhaust brake is on and functioning.</p> <p>Check connection to exhaust brake activation wire.</p> <p>Check power (fuse) and ground.</p>

For ease of troubleshooting, if power is removed from the unit all factory signals will take precedence. For example, to diagnose an up-shifting problem, remove the power from the AutoLoc to properly diagnose the problem. With power removed from the AutoLoc, the factory transmission signals will not be altered, they will simply pass right through the unit and out. If the problem still occurs, you can connect the TCC and PCS wiring back together. Remember, the first step is to always check the wiring connections visibly and then with a voltmeter.

Troubleshooting

Version 2

For one whenever the brake controller is powered there will be a flashing light. This shows that the unit has power and the microprocessor is functioning normally. The second LED comes on when the Brake Output is energized. For example when you press the test button.

Version 2.01 and Newer

This unit does away with the blinking light. There will be a Red LED that operates when the Brake Output is energized This shows that the brake is being requested to activate. The green LED will only come on once the VSS signal is met. So below 15 mph the LED will be off above 25 mph the LED will be on.

As well you will notice an "EBP ADJ" potentiometer on the side of the brake controller. The potentiometer is only used if you run into EGR problems. Please contact BD before adjusting this.

ATTENTION

P0299 CODE: If after installing the exhaust brake you receive a P0299 DTC, please set the APPS activation on the brake controller closer to idle. Also remove the small brass plug with a small hole in it from the back of the quick release valve on the exhaust brake air cylinder.

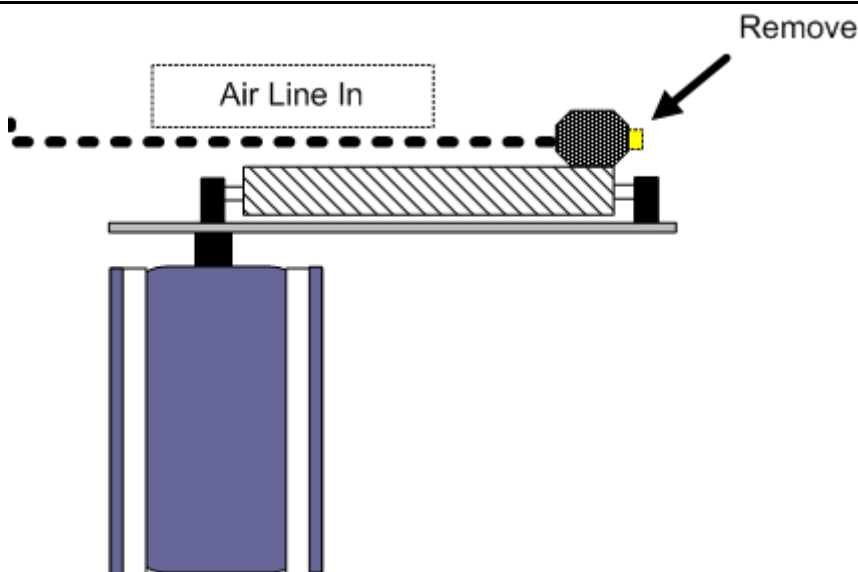

BD Engine Brake Inc.

Plant Address: 33541 MacLure Rd. Abbotsford, BC, Canada V2S 7W2

U.S. Shipping Address: 88-446 Harrison St, Sumas, WA 98295 U.S. Mailing Address: P.O. Box 231, Sumas, WA 98295

Phone: 604-853-6096 | Fax: 604-853-8749 | Internet: www.bd-power.com